

Service. Quality. Reliability.



**GRATING PACIFIC**

BAR GRATING CATALOG

# Welcome

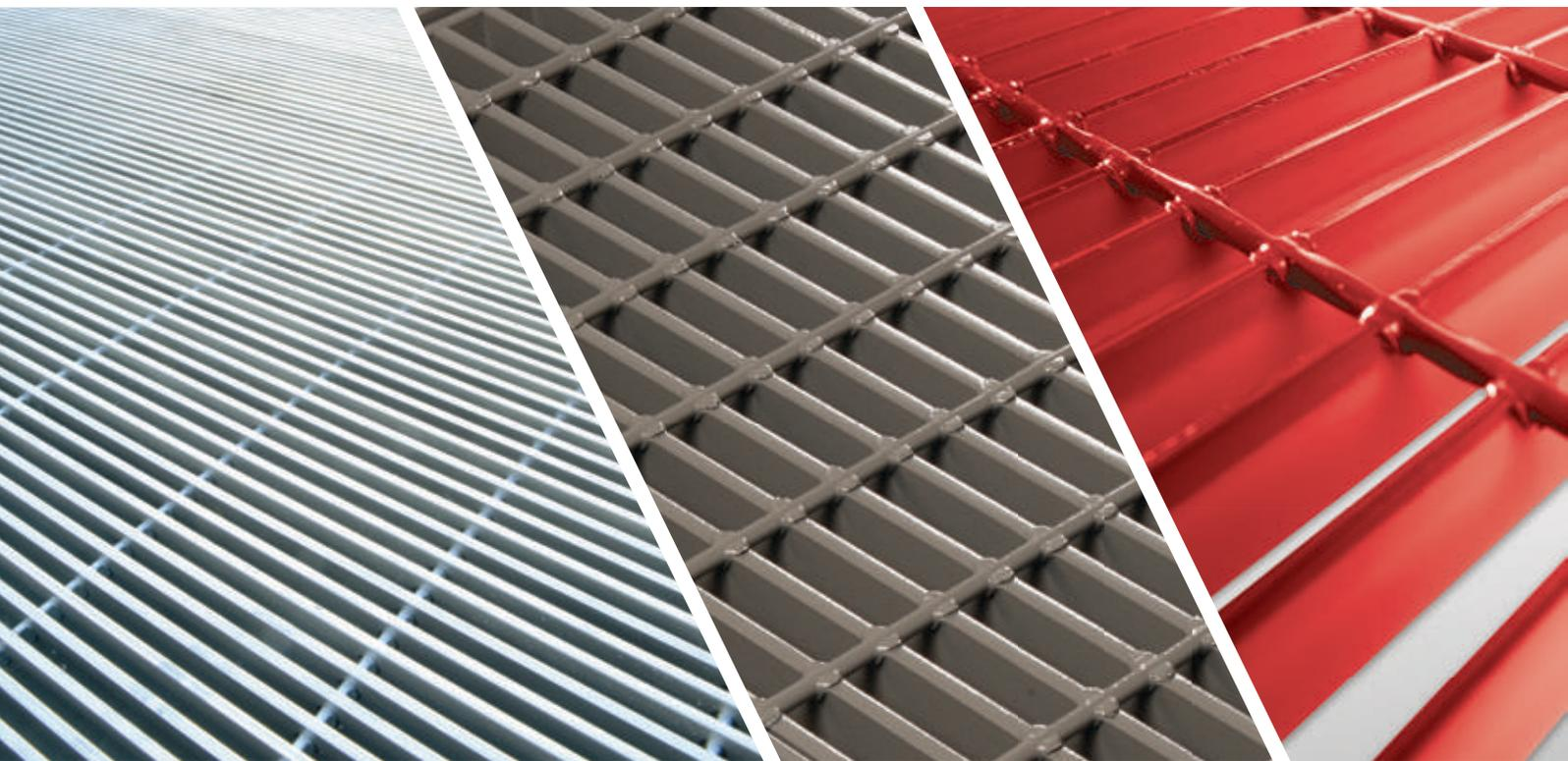

## To the Reader

The following presentation of bar grating products has been compiled to serve the diverse needs of design professionals as well as the specific needs of the end user.

By describing the extensive line of bar gratings offered by Grating Pacific, this catalog serves as a useful tool for defining materials, methods of assembly, fabrication, and finish alternatives. Whether your needs include only a simple stair and platform or an entire industrial processing facility, the products described in this catalog offer a comprehensive menu of open metal flooring features from which the most appropriate may be selected.

## The Bar Grating Advantage

For nearly a century, metal bar grating has been the predominant choice for open metal flooring. Features that make bar grating the preferred product include:

- **Appropriate Materials** – Carbon steel, aluminum, stainless steel, and specialty alloys provide safe, durable, and functional products for nearly all environments.
- **High Percentage of Open Area** – Typically ranging from 50 to 80 percent, allows for the unhindered passage of light, air, and liquids reducing costs for lighting, ventilation, and fire suppression.
- **High Strength-to-Weight Ratio** – Designed for maximum efficiency and capable of supporting loads ranging from light pedestrian traffic to the heaviest vehicular and aircraft loads.
- **Product Flexibility** – Easily fabricated to suit the exact configuration of your application.
- **Economy** – Commonly shop fabricated and finished to meet the specific intricacies of each project. Once delivered to the site and fastened in place the floor is immediately ready for service.
- **Maintenance-Free** – The high percentage of open area allows for excellent drainage and the free passing of debris, thus creating a virtually maintenance-free floor.

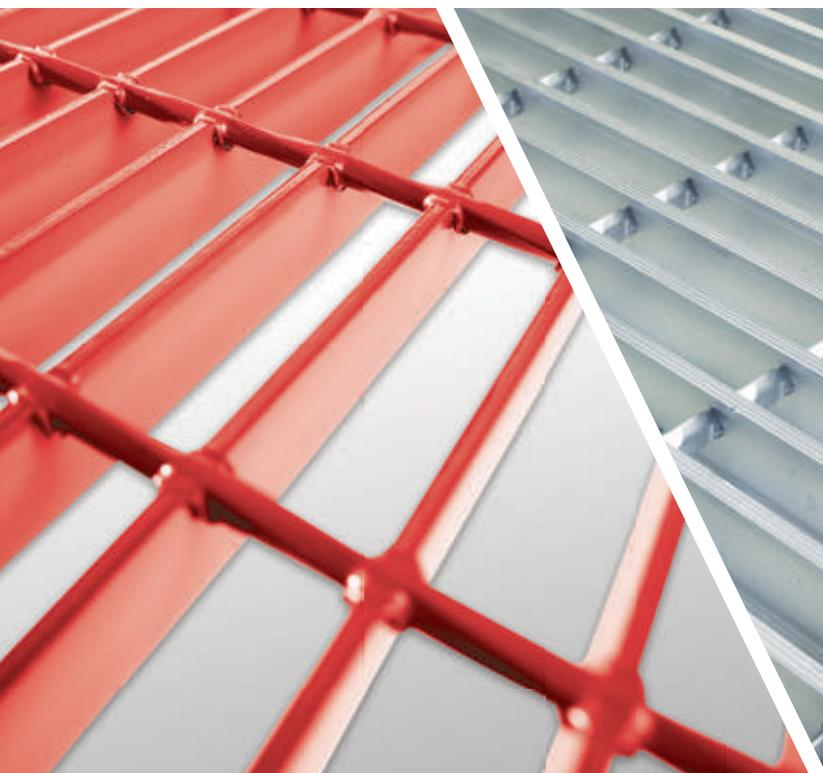

## Service. Quality. Reliability.

Founded in 1971 on the unyielding principle of “Service First,” Grating Pacific has grown to include five service centers strategically located in the western United States. As our business evolved, it became apparent that unparalleled service also demanded premium quality and steadfast reliability as we partner with our customers to deliver products to an ever expanding market. Each of us at Grating Pacific welcome the opportunity to deliver every aspect of our business with **Service. Quality. Reliability.**



NAAMM – The National Association of Architectural Metal Manufacturers consists of five operating divisions, each focused on specific metal products for building and related applications. Each division develops and maintains technical standards for its products and actively promotes their use by design professionals.

The Metal Bar Grating Division of NAAMM publishes the only manuals for standard and heavy duty gratings which are recognized by ANSI, the American National Standards Institute. These ANSI/NAAMM standards are your guide in assuring that your grating needs are satisfied by products of consistent quality and availability.

Grating Pacific, an active NAAMM member in good standing, designs, manufactures and fabricates bar grating in strict accordance with published NAAMM standards. Supporting engineering documentation is available upon request.

<b>Introduction</b>	<b>2</b>
<b>Product Specification</b>	<b>3</b>
<b>Steel Bar Grating</b>	
Overview	<b>4-5</b>
Load Tables	<b>6-10</b>
Stair Treads	<b>11</b>
<b>Aluminum Bar Grating</b>	
Overview	<b>12-13</b>
Load Tables	<b>14-18</b>
Stair Treads	<b>19</b>
<b>Aluminum Plank Grating</b>	
Overview	<b>20</b>
Load Tables	<b>21</b>
<b>Stainless Steel Bar Grating</b>	
Overview	<b>22-23</b>
Load Tables	<b>24-28</b>
Stair Treads	<b>29</b>
<b>Riveted Grating</b>	
Overview	<b>30</b>
Load Tables	<b>31-33</b>
<b>ALGRIP™ Grating &amp; Plate</b>	<b>34-35</b>
<b>Heavy Duty Steel Grating</b>	
Overview	<b>36-37</b>
Load Tables	<b>38-42</b>
<b>Bridge Decking</b>	<b>43</b>
<b>Embed Frames</b>	<b>44-45</b>
<b>Trench &amp; Inlet Systems</b>	<b>46-49</b>
<b>Coda Architectural® Products</b>	<b>50-53</b>
<b>Louver Grate &amp; Architectural Gratings</b>	<b>54-57</b>
<b>Installation Information</b>	
Banding & Panel Layout	<b>58</b>
Fasteners	<b>59</b>
Manufacturing & Installation	<b>60</b>
<b>Glossary</b>	<b>61</b>

# Introduction

**Metal Bar Grating** is the workhorse of the industrial flooring market and has served industry for decades. Strong and durable with an exceptional strength-to-weight ratio, metal bar grating can be easily fabricated to nearly any configuration. The high percentage of open area makes bar grating practically maintenance-free and all products are fully recyclable.

Manufactured by assembling a series of equally spaced metal bars to connecting cross members, bar grating is available in three popular materials; mild carbon steel, 6000 series aluminum, and 300 series stainless steels. Additionally, Grating Pacific has the capacity to produce gratings constructed with other specialty metal alloys.

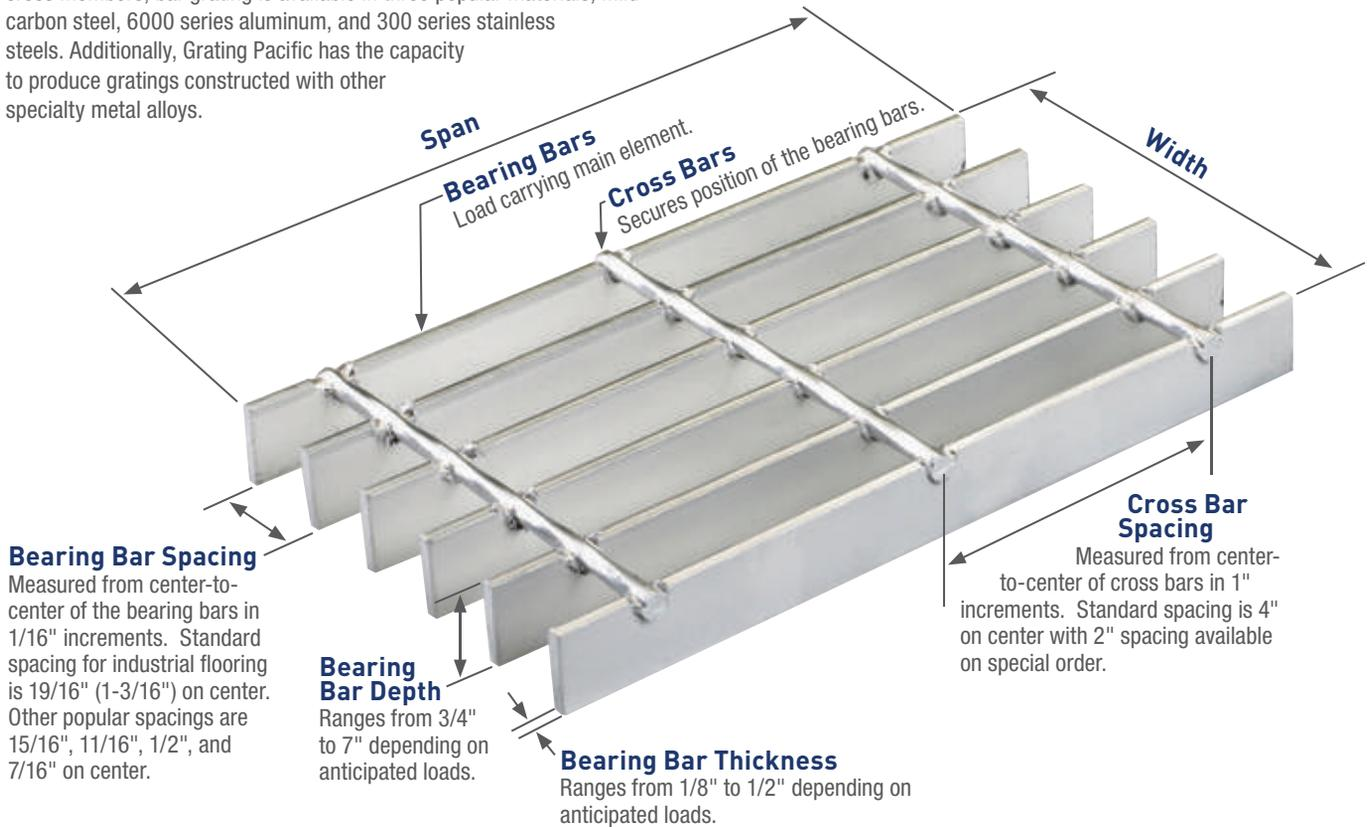

## Manufacturing Methods



### Welded Grating

Economical design ideal for most industrial applications. Manufactured by welding the bearing bar/cross bar intersection, typically with automated forge welding equipment. Available in carbon steel and stainless steel.



### Dovetail Pressure Locked Grating

Assembled by inserting pre-punched bearing and cross bars into an "egg-crate" configuration and deforming the cross bars under intense hydraulic pressure. Available in all materials and ideal for architectural and ornamental applications.



### Swage Locked Grating

Popular for the manufacture of aluminum, stainless steel, and close mesh gratings. Cross bars are inserted into pre-punched holes in the bearing bars and hydraulically deformed to lock the bars in place.

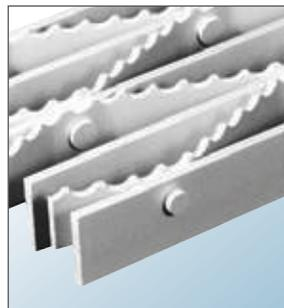

### Riveted Grating

Exceptionally durable grating manufactured by riveting bearing bars and bent connecting bars at their contact points. Excellent for applications involving impact loads and repetitive traffic patterns.

## Service Loads

The load tables on the pages within this catalog provide load/deflection criteria for most common applications. These tables provide a concise reference allowing the specifying authority to select the appropriate bearing bar size and spacing for the intended application.

Pedestrian loads are commonly analyzed with uniform and concentrated loads. For pedestrian comfort, deflection is typically limited to 1/4".

Heavy duty and vehicular load tables are presented for specific load conditions. Heavy duty load tables are presented with deflection limited to the lesser of 1/8" or L/400.

If your application is not addressed by the load tables found in this catalog, please contact Grating Pacific for assistance selecting the product most appropriate for your application.

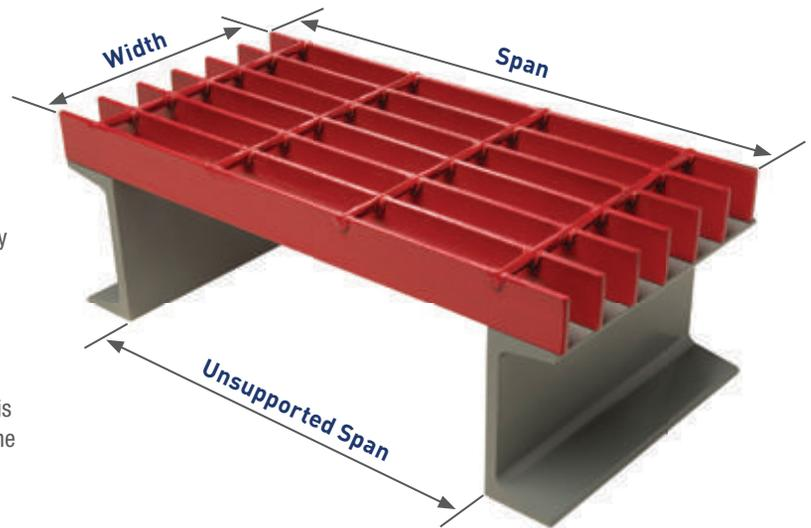

## Specification Criteria

When specifying metal bar grating it is important to consider the following factors:

- Service load required and acceptable deflection
- Unsupported clear span
- Flooring surface
- Banding and trim
- Finish

## Surface Options



### Plain Surface

Standard surface with excellent "self-cleaning" characteristics. Suitable for most applications.



### Serrated Surface

Preferred for applications where moisture or fluids cause the walking surface to become wet and slippery.



### Algrip™ Surface

Durable slip-resistant deposits on the walking surface provide enhanced slip-resistance for applications in the public way (see page 34).

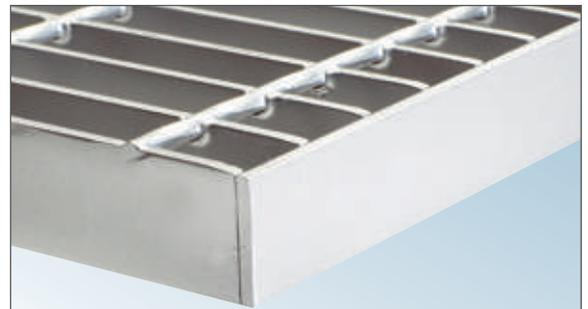

## Banding

The open ends of the grating may be banded to provide additional transverse stiffness and a finished architectural appearance. Achieved by welding a flat bar, similar in size to the bearing bars, to the cut end, banding enhances safety and should always be specified when gratings are designed to be removable.

Banding can reduce impact stress by transferring load to adjacent bearing bars and should always be specified when gratings are subject to vehicular loads. Further banding descriptions and details may be found on page 58.

## Finishes

**Steel** products are commonly provided with one of three finishes: bare steel (no finish); painted with one coat of manufacturer's red, black or silver paint; or hot dip galvanized in accordance with ASTM A-123.

**Aluminum** products are offered mill finish with optional chemical cleaning or anodizing also available.

**Stainless Steel** products typically require secondary cleaning due to discoloration that occurs during welding and fabrication. Commercial cleaning, passivation, or abrasive blasting can provide a uniform matte surface while electro-polishing leaves a bright stainless finish.

**Other** - All products can be provided with specialty finishes including enamel or epoxy paints, or powder coating. When considering specialty finishes, contact Grating Pacific for consultation.



Painted Steel

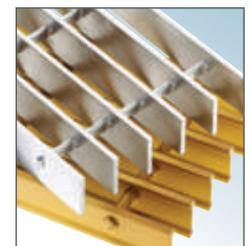

Mill Finished & Anodized Aluminum

# Steel Bar Grating

## Steel Bar Grating

Steel bar grating is manufactured from ASTM A-1011 mild carbon steel and is available in three distinct products: type "W" welded bar grating, type "DT" dovetail pressure locked grating, and type "SL" swage locked grating. All three products are available with bearing bar spacing ranging from 19/16" (1-3/16") to 7/16" on center and with cross bars at either 4" or 2" on center.

Each product has a standard plain surface or may be specified with optional serrated or Algrip surfaces. Finish options include bare steel, painted, hot dip galvanized, or specialty coatings.

The load tables on pages 6-10 provide detailed specification information related to these products.

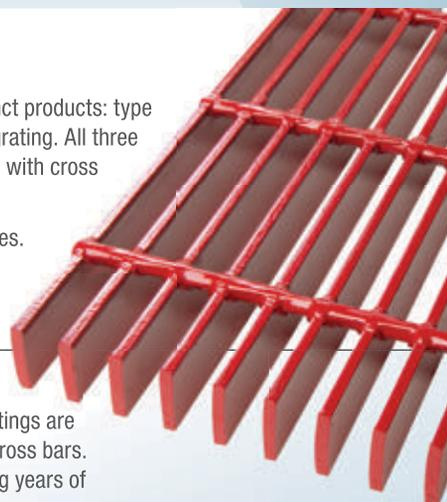

Type  
11-W-4

### Type "W" Welded Steel Grating

Our most economical steel grating products, type "W" welded steel gratings are manufactured by forge welding rectangular bearing bars and drawn cross bars. This welding process provides a positive fused connection providing years of service under the most demanding conditions.

Type 19-W-4 steel grating is our most popular product and is recommended for nearly all industrial flooring applications. With nearly 80% open area, 19-W-4 allows for the easy passage of dirt, debris, snow, and liquids and is essentially self-cleaning.

Type "W" gratings are available in close mesh, ADA conforming spacings 11-W-4 and 7-W-4 which are commonly used in public areas.

When specifying type 11-W-4 for ADA applications, 3/16" thick bearing bars must be specified.

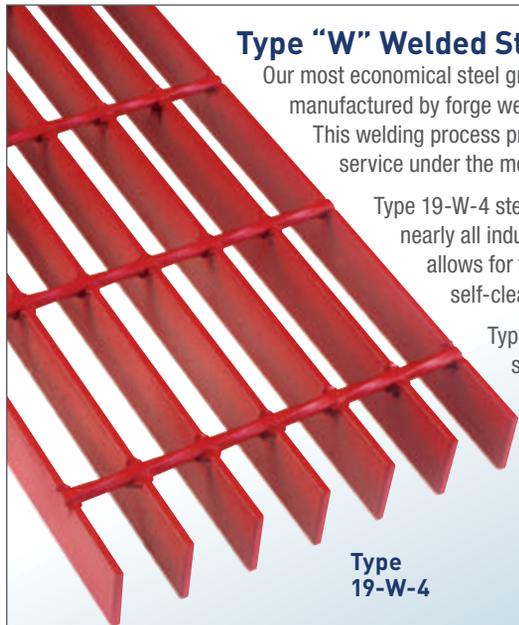

Type  
19-W-4

### WELDED STEEL INTERSECTION

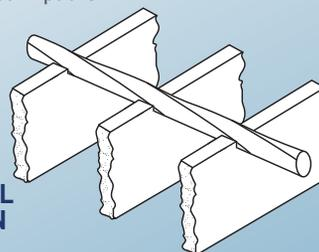

### Type "DT" Dovetail Pressure Locked Steel Grating

Type "DT" steel gratings have deep rectangular cross bars and are manufactured by inserting pre-punched bearing bars and cross bars into an "egg-crate" configuration and deforming the cross bars under intense hydraulic pressure.

The deep cross bars on type "DT" gratings make them popular for architectural applications such as sun shades and infill panels with the deeper cross bar serving as a distinct architectural accent.

### DOVETAIL INTERSECTION

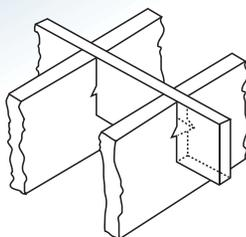

### Type "SL" Swage Locked Steel Grating

Type "SL" steel gratings are manufactured by inserting hollow tube cross bars into pre-punched holes in the bearing bars. The cross bars are then swaged forming a positive mechanical connection. The cross bars are recessed below the top surface of the bearing bars providing a uniform and attractive architectural appearance.

Swage locking is a particularly efficient process for the production of close mesh gratings. Type 7-SL-4 with 3/16" thick bearing bars provides a net 1/4" clear opening between the bearing bars. This narrow opening is often preferred in public areas where concerns of drainage and the presence of high heeled shoes converge.

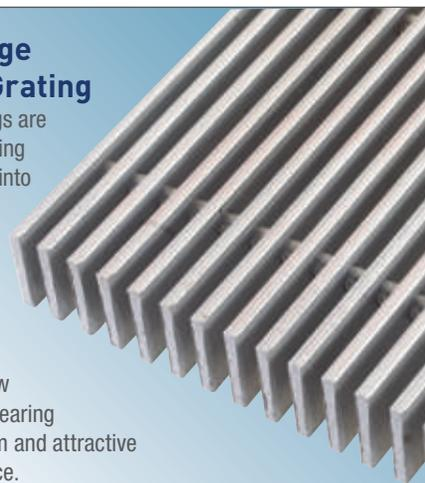

### SWAGED INTERSECTION

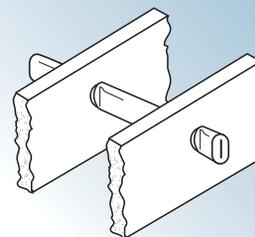

## Steel Grating Table of Spacings

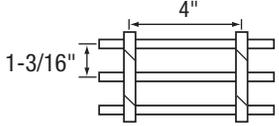
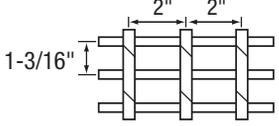
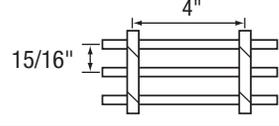
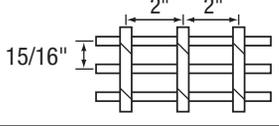
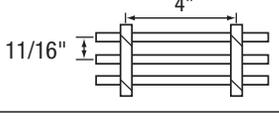
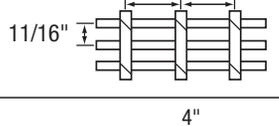
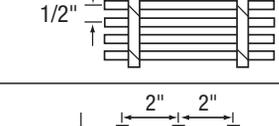
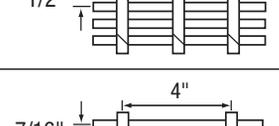
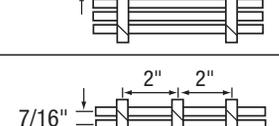
Part No.	Spacing	Open Area*	
19-W-4 19-DT-4 19-SL-4		78%	Bearing bars spaced at 1-3/16" on center and cross bars at 4" on center. The workhorse of industrial flooring, popular for platforms, catwalks, mezzanines, and stairways.
19-W-2 19-DT-2 19-SL-2		73%	Bearing bars spaced at 1-3/16" on center and cross bars at 2" on center. Excellent for short spans and applications where small wheeled carts continuously cross the grating surface.
15-W-4 15-DT-4 15-SL-4		75%	Bearing bars spaced at 15/16" on center and cross bars at 4" on center. The closer spaced bearing bars increase load capacity by more than 26% when compared to similar gratings produced with bearing bars at 1-3/16" on center.
15-W-2 15-DT-2 15-SL-2		69%	Bearing bars spaced at 15/16" on center and cross bars at 2" on center. The closer spaced bearing bars and cross bars provide additional flooring surface to support pedestrian and wheeled traffic.
11-W-4 11-DT-4 11-SL-4		68%	Bearing bars spaced at 11/16" on center and cross bars at either 4" or 2" on center. Types 11-4 and 11-2 with 3/16" thick bearing bars comply with the spacing requirements of the Americans with Disabilities Act. For ADA installations, specify that the bearing bars span perpendicular to the normal flow of traffic.
11-W-2 11-DT-2 11-SL-2		63%	
8-W-4 8-DT-4 8-SL-4		58%	Bearing bars spaced at 1/2" on center and cross bars at 4" or 2" on center. Types 8-4 and 8-2 comply with ADA spacing requirements. These products are popular for material handling platforms and mezzanines subject to continuous cart and dolly traffic.
8-W-2 8-DT-2 8-SL-2		54%	
7-W-4 7-DT-4 7-SL-4		53%	Bearing bars spaced at 7/16" on center and cross bars at 4" or 2" on center. Types 7-4 and 7-2 comply with ADA spacing requirements and are popular for applications in the public way. When specified with 3/16" thick bearing bars, 7-4 and 7-2 gratings have a net 1/4" clear opening between the bearing bars and commonly reject intrusion by high heeled shoes.
7-W-2 7-DT-2 7-SL-2		49%	

\* Percentage of open area is based upon 3/16" thick bearing bars and .275" cross bars. Contact Grating Pacific if exact open area calculation is required for alternative bearing bar thicknesses or cross bar sizes.

### How to Specify Steel Bar Grating

- Select type of grating
  - "W" for welded steel grating
  - "DT" for dovetail pressure locked grating
  - "SL" for swage locked grating
- Select bar spacing from table above
- Select bearing bar size (consult load tables on pages 6-10 considering service loads and clear spans)
- Specify plain, serrated, or Algrip surface
- Specify banding or additional trim required
- Specify finish
  - Bare steel (no finish)
  - Painted (red, black, silver, other)
  - Hot dip galvanized (per ASTM A-123)
  - Other
- Specify fasteners (if required) – see page 59

# Steel Bar Grating

## 19 Space (1-3/16") Load Table

Use this table when evaluating spans and loads for the following types of steel grating:  
**19-W-4, 19-W-2, 19-DT-4, 19-DT-2, 19-SL-4, & 19-SL-2**

Bearing Bar Size (inches)	Approx. Weight psf*	Max. Ped. Span**	Sec. Prop.*** Sx in <sup>3</sup> Ix in <sup>4</sup>		Unsupported Span																	
					2'-0"	2'-6"	3'-0"	3'-6"	4'-0"	4'-6"	5'-0"	5'-6"	6'-0"	6'-6"	7'-0"	8'-0"	9'-0"					
3/4 x 1/8	3.9	3'-5"	0.118 0.044	U	355	227	158	116	89	70	All loads and deflections are theoretical and based upon the gross sections of the bearing bars, using a fiber stress of 18,000 psi.  The values are not intended to be absolute since the actual load capacity will be affected by the slight variations in mill and manufacturing tolerances.  Grating for spans to the left of the heavy line have a deflection ≤ 1/4" for uniform loads of 100 psf.  U = uniform load in pounds/sq. ft. C = concentrated load in pounds/ft. of grating width D = deflection in inches											
				D	0.099	0.155	0.223	0.304	0.397	0.503												
				C	355	284	237	203	178	158												
				D	0.079	0.124	0.179	0.243	0.318	0.402												
3/4 x 3/16	5.6	3'-10"	0.178 0.067	U	533	341	237	174	133	105											85	
				D	0.099	0.155	0.223	0.304	0.397	0.503											0.621	
				C	533	426	355	305	266	237											213	
				D	0.079	0.124	0.179	0.243	0.318	0.402											0.497	
1 x 1/8	5.0	4'-3"	0.211 0.105	U	632	404	281	206	158	125											101	84
				D	0.074	0.116	0.168	0.228	0.298	0.377											0.466	0.563
				C	632	505	421	361	316	281											253	230
				D	0.060	0.093	0.134	0.182	0.238	0.302											0.372	0.451
1 x 3/16	7.2	4'-9"	0.316 0.158	U	947	606	421	309	237	187	152	125	105									
				D	0.074	0.116	0.168	0.228	0.298	0.377	0.466	0.563	0.670									
				C	947	758	632	541	474	421	379	345	316									
				D	0.060	0.093	0.134	0.182	0.238	0.302	0.372	0.451	0.536									
1-1/4 x 1/8	6.1	5'-1"	0.329 0.206	U	987	632	439	322	247	195	158	131	110	93								
				D	0.060	0.093	0.134	0.182	0.238	0.302	0.372	0.451	0.536	0.629								
				C	987	790	658	564	493	439	395	359	329	304								
				D	0.048	0.074	0.107	0.146	0.191	0.241	0.298	0.360	0.429	0.504								
1-1/4 x 3/16	8.9	5'-7"	0.493 0.308	U	1,480	947	658	483	370	292	237	196	165	140	121							
				D	0.060	0.093	0.134	0.182	0.238	0.302	0.372	0.451	0.536	0.629	0.730							
				C	1,480	1,184	987	846	740	658	592	538	493	456	423							
				D	0.048	0.074	0.107	0.146	0.191	0.241	0.298	0.360	0.429	0.504	0.584							
1-1/2 x 1/8	7.2	5'-10"	0.474 0.355	U	1,421	910	632	464	355	281	227	188	158	135	116							
				D	0.050	0.078	0.112	0.152	0.199	0.251	0.310	0.376	0.447	0.524	0.608							
				C	1,421	1,137	947	812	711	632	568	517	474	437	406							
				D	0.040	0.062	0.089	0.122	0.159	0.201	0.248	0.300	0.358	0.420	0.487							
1-1/2 x 3/16	10.7	6'-5"	0.711 0.533	U	2,132	1,364	947	696	533	421	341	282	237	202	174	133						
				D	0.050	0.078	0.112	0.152	0.199	0.251	0.310	0.376	0.447	0.524	0.608	0.794						
				C	2,132	1,705	1,421	1,218	1,066	947	853	775	711	656	609	533						
				D	0.040	0.062	0.089	0.122	0.159	0.201	0.248	0.300	0.358	0.420	0.487	0.636						
1-3/4 x 1/8	8.5	6'-6"	0.645 0.564	U	1,934	1,238	860	632	484	382	310	256	215	183	158	121						
				D	0.043	0.067	0.096	0.130	0.170	0.215	0.266	0.322	0.383	0.450	0.521	0.681	0.862					
				C	1,934	1,547	1,290	1,105	967	860	774	703	645	595	553	484	430					
				D	0.034	0.053	0.077	0.104	0.136	0.172	0.213	0.257	0.306	0.360	0.417	0.545	0.689					
1-3/4 x 3/16	12.3	7'-3"	0.967 0.846	U	2,901	1,857	1,290	947	725	573	464	384	322	275	237	181						
				D	0.043	0.067	0.096	0.130	0.170	0.215	0.266	0.322	0.383	0.450	0.521	0.681	0.862					
				C	2,901	2,321	1,934	1,658	1,451	1,290	1,161	1,055	967	893	829	725	645					
				D	0.034	0.053	0.077	0.104	0.136	0.172	0.213	0.257	0.306	0.360	0.417	0.545	0.689					
2 x 1/8	9.6	7'-4"	0.842 0.842	U	2,526	1,617	1,123	825	632	499	404	334	281	239	206	158						
				D	0.037	0.058	0.084	0.114	0.149	0.189	0.233	0.282	0.335	0.393	0.456	0.596	0.754					
				C	2,526	2,021	1,684	1,444	1,263	1,123	1,011	919	842	777	722	632	561					
				D	0.030	0.047	0.067	0.091	0.119	0.151	0.186	0.225	0.268	0.315	0.365	0.477	0.603					
2 x 3/16	13.9	8'-0"	1.263 1.263	U	3,790	2,425	1,684	1,237	947	749	606	501	421	359	309	237						
				D	0.037	0.058	0.084	0.114	0.149	0.189	0.233	0.282	0.335	0.393	0.456	0.596	0.754					
				C	3,790	3,032	2,526	2,165	1,895	1,684	1,516	1,378	1,263	1,166	1,083	947	842					
				D	0.030	0.047	0.067	0.091	0.119	0.151	0.186	0.225	0.268	0.315	0.365	0.477	0.603					
2-1/4 x 3/16	15.6	8'-9"	1.599 1.799	U	4,796	3,070	2,132	1,566	1,199	947	767	634	533	454	392	300						
				D	0.033	0.052	0.074	0.101	0.132	0.168	0.207	0.250	0.298	0.350	0.406	0.530	0.670					
				C	4,796	3,837	3,197	2,741	2,398	2,132	1,918	1,744	1,599	1,476	1,370	1,199	1,066					
				D	0.026	0.041	0.060	0.081	0.106	0.134	0.166	0.200	0.238	0.280	0.324	0.424	0.536					
2-1/2 x 3/16	17.2	9'-5"	1.974 2.467	U	5,921	3,790	2,632	1,933	1,480	1,170	947	783	658	561	483	370						
				D	0.030	0.047	0.067	0.091	0.119	0.151	0.186	0.225	0.268	0.315	0.365	0.477	0.603					
				C	5,921	4,737	3,947	3,384	2,961	2,632	2,368	2,153	1,974	1,822	1,692	1,480	1,316					
				D	0.024	0.037	0.054	0.073	0.095	0.121	0.149	0.180	0.215	0.252	0.292	0.381	0.483					

\* Weight per square foot based upon 19-W-4 grating. Add .60 psf for 2" on center cross bars. \*\* Maximum pedestrian load is defined as a 100# uniform load with deflection ≤ 1/4 inch. (The 1/4" maximum deflection criteria is considered consistent with pedestrian comfort, but may be exceeded for other loading conditions at the discretion of the specifying authority.) \*\*\* Section properties per foot of width.

Note: When gratings with serrated surface are specified, the depth of the grating required for a specific load will be 1/4" greater than that shown in these tables.

### Panel Widths

Grating panels are available from stock in nominal 24", 36" and 48" widths. When considering alternative widths, consult this table to select widths that will maintain uniform "out-to-out" spacing of the bearing bars. Specified widths deviating from this table will be fabricated to size with side banding and the bar spacing on one side of the finished panel will vary from the spacing throughout the remainder of the panel.

Number of Bearing Bars	2	3	4	5	6	7	8	9	10	11	12	13	14	15	16
Panel Width	1-3/8"	2-9/16"	3-3/4"	4-15/16"	6-1/8"	7-5/16"	8-1/2"	9-11/16"	10-7/8"	12-1/16"	13-1/4"	14-7/16"	15-5/8"	16-13/16"	18"
Number of Bearing Bars	17	18	19	20	21	22	23	24	25	26	27	28	29	30	31
Panel Width	19-3/16"	20-3/8"	21-9/16"	22-3/4"	23-15/16"	25-1/8"	26-5/16"	27-1/2"	28-11/16"	29-7/8"	31-1/16"	32-1/4"	33-7/16"	34-5/8"	35-13/16"
Number of Bearing Bars	32	33	34	35	36	37	38	39	40	41	Panel widths indicated are for gratings with 3/16" thick bearing bars. For 1/8" thick bearing bars deduct 1/16" from the stated values.				
Panel Width	37"	38-3/16"	39-3/8"	40-9/16"	41-3/4"	42-15/16"	44-1/8"	45-5/16"	46-1/2"	47-11/16"					

█ Indicates stock panel widths.

## 15 Space (15/16") Load Table

Use this table when evaluating spans and loads for the following types of steel grating:  
**15-W-4, 15-W-2, 15-DT-4, 15-DT-2, 15-SL-4, & 15-SL-2**

Bearing Bar Size (inches)	Approx. Weight psf *	Max. Ped. Span**	Sec. Prop.*** Sx in <sup>3</sup> Ix in <sup>4</sup>	Unsupported Span															
				2'-0"	2'-6"	3'-0"	3'-6"	4'-0"	4'-6"	5'-0"	5'-6"	6'-0"	6'-6"	7'-0"	8'-0"	9'-0"			
3/4 x 3/16	6.9	4'-0"	0.225 0.084	U	675	432	300	220	169	133	108	All loads and deflections are theoretical and based upon the gross sections of the bearing bars, using a fiber stress of 18,000 psi. The values are not intended to be absolute since the actual load capacity will be affected by the slight variations in mill and manufacturing tolerances. Grating for spans to the left of the heavy line have a deflection ≤ 1/4" for uniform loads of 100 psf. U = uniform load in pounds/sq. ft. C = concentrated load in pounds/ft. of grating width D = deflection in inches							
				D	0.099	0.155	0.223	0.304	0.397	0.503	0.621								
				C	675	540	450	386	338	300	270								
				D	0.079	0.124	0.179	0.243	0.318	0.402	0.497								
1 x 1/8	6.2	4'-6"	0.267 0.133	U	800	512	356	261	200	158	128								
				D	0.074	0.116	0.168	0.228	0.298	0.377	0.466								
				C	800	640	533	457	400	356	320								
				D	0.060	0.093	0.134	0.182	0.238	0.302	0.372								
1 x 3/16	8.9	5'-0"	0.400 0.200	U	1,200	768	533	392	300	237	192	159	133						
				D	0.074	0.116	0.168	0.228	0.298	0.377	0.466								
				C	1,200	960	800	686	600	533	480	436	400						
				D	0.060	0.093	0.134	0.182	0.238	0.302	0.372	0.451	0.536						
1-1/4 x 1/8	7.5	5'-4"	0.417 0.260	U	1,250	800	556	408	313	247	200	165	139	118					
				D	0.060	0.093	0.134	0.182	0.238	0.302	0.372	0.451	0.536	0.629					
				C	1,250	1,000	833	714	625	556	500	455	417	385					
				D	0.048	0.074	0.107	0.146	0.191	0.241	0.298	0.360	0.429	0.504					
1-1/4 x 3/16	11.0	5'-11"	0.625 0.391	U	1,875	1,200	833	612	469	370	300	248	208	178	153				
				D	0.060	0.093	0.134	0.182	0.238	0.302	0.372	0.451	0.536	0.629	0.730				
				C	1,875	1,500	1,250	1,071	938	833	750	682	625	577	536				
				D	0.048	0.074	0.107	0.146	0.191	0.241	0.298	0.360	0.429	0.504	0.584				
1-1/2 x 1/8	8.9	6'-2"	0.600 0.450	U	1,800	1,152	800	588	450	356	288	238	200	170	147	113			
				D	0.050	0.078	0.112	0.152	0.199	0.251	0.310	0.376	0.447	0.524	0.608	0.794			
				C	1,800	1,440	1,200	1,029	900	800	720	655	600	554	514	450			
				D	0.040	0.062	0.089	0.122	0.159	0.201	0.248	0.300	0.358	0.420	0.487	0.636			
1-1/2 x 3/16	13.2	6'-10"	0.900 0.675	U	2,700	1,728	1,200	882	675	533	432	357	300	256	220	169	133		
				D	0.050	0.078	0.112	0.152	0.199	0.251	0.310	0.376	0.447	0.524	0.608	0.794	1.006		
				C	2,700	2,160	1,800	1,543	1,350	1,200	1,080	982	900	831	771	675	600		
				D	0.040	0.062	0.089	0.122	0.159	0.201	0.248	0.300	0.358	0.420	0.487	0.636	0.804		
1-3/4 x 1/8	10.4	6'-11"	0.817 0.715	U	2,450	1,568	1,089	800	613	484	392	324	272	232	200	153	121		
				D	0.043	0.067	0.096	0.130	0.170	0.215	0.266	0.322	0.383	0.450	0.521	0.681	0.862		
				C	2,450	1,960	1,633	1,400	1,225	1,089	980	891	817	754	700	613	544		
				D	0.034	0.053	0.077	0.104	0.136	0.172	0.213	0.257	0.306	0.360	0.417	0.545	0.689		
1-3/4 x 3/16	15.3	7'-8"	1.225 1.072	U	3,675	2,352	1,633	1,200	919	726	588	486	408	348	300	230	182		
				D	0.043	0.067	0.096	0.130	0.170	0.215	0.266	0.322	0.383	0.450	0.521	0.681	0.862		
				C	3,675	2,940	2,450	2,100	1,838	1,633	1,470	1,336	1,225	1,131	1,050	919	817		
				D	0.034	0.053	0.077	0.104	0.136	0.172	0.213	0.257	0.306	0.360	0.417	0.545	0.689		
2 x 1/8	11.8	7'-7"	1.067 1.067	U	3,200	2,048	1,422	1,045	800	632	512	423	356	303	261	200	158		
				D	0.037	0.058	0.084	0.114	0.149	0.189	0.233	0.282	0.335	0.393	0.456	0.596	0.754		
				C	3,200	2,560	2,133	1,829	1,600	1,422	1,280	1,164	1,067	985	914	800	711		
				D	0.030	0.047	0.067	0.091	0.119	0.151	0.186	0.225	0.268	0.315	0.365	0.477	0.603		
2 x 3/16	17.3	8'-6"	1.600 1.600	U	4,800	3,072	2,133	1,567	1,200	948	768	635	533	454	392	300	237		
				D	0.037	0.058	0.084	0.114	0.149	0.189	0.233	0.282	0.335	0.393	0.456	0.596	0.754		
				C	4,800	3,840	3,200	2,743	2,400	2,133	1,920	1,746	1,600	1,477	1,371	1,200	1,067		
				D	0.030	0.047	0.067	0.091	0.119	0.151	0.186	0.225	0.268	0.315	0.365	0.477	0.603		
2-1/4 x 3/16	19.4	9'-3"	2.025 2.278	U	6,075	3,888	2,700	1,984	1,519	1,200	972	803	675	575	496	380	300		
				D	0.033	0.052	0.074	0.101	0.132	0.168	0.207	0.250	0.298	0.350	0.406	0.530	0.670		
				C	6,075	4,860	4,050	3,471	3,038	2,700	2,430	2,209	2,025	1,869	1,736	1,519	1,350		
				D	0.026	0.041	0.060	0.081	0.106	0.134	0.166	0.200	0.238	0.280	0.324	0.424	0.536		
2-1/2 x 3/16	21.5	10'-0"	2.500 3.125	U	7,500	4,800	3,333	2,449	1,875	1,482	1,200	992	833	710	612	469	370		
				D	0.030	0.047	0.067	0.091	0.119	0.151	0.186	0.225	0.268	0.315	0.365	0.477	0.603		
				C	7,500	6,000	5,000	4,286	3,750	3,333	3,000	2,727	2,500	2,308	2,143	1,875	1,667		
				D	0.024	0.037	0.054	0.073	0.095	0.121	0.149	0.180	0.215	0.252	0.292	0.381	0.483		

\* Weight per square foot based upon 15-W-4 grating. Add .60 psf for 2" on center cross bars. \*\* Maximum pedestrian load is defined as a 100# uniform load with deflection ≤ 1/4 inch. (The 1/4" maximum deflection criteria is considered consistent with pedestrian comfort, but may be exceeded for other loading conditions at the discretion of the specifying authority.) \*\*\* Section properties per foot of width.  
**Note: When gratings with serrated surface are specified, the depth of the grating required for a specific load will be 1/4" greater than that shown in these tables.**

### Panel Widths

Grating panels are available from stock in nominal 24" and 36" widths. When considering alternative widths, consult this table to select widths that will maintain uniform "out-to-out" spacing of the bearing bars. Specified widths deviating from this table will be fabricated to size with side banding and the bar spacing on one side of the finished panel will vary from the spacing throughout the remainder of the panel.

Number of Bearing Bars	2	3	4	5	6	7	8	9	10	11	12	13	14	15	16
Panel Width	1-1/8"	2-1/16"	3"	3-15/16"	4-7/8"	5-13/16"	6-3/4"	7-11/16"	8-5/8"	9-9/16"	10-1/2"	11-7/16"	12-3/8"	13-5/16"	14-1/4"
Number of Bearing Bars	17	18	19	20	21	22	23	24	25	26	27	28	29	30	31
Panel Width	15-3/16"	16-1/8"	17-1/16"	18"	18-15/16"	19-7/8"	20-13/16"	21-3/4"	22-11/16"	23-5/8"	24-9/16"	25-1/2"	26-7/16"	27-3/8"	28-5/16"
Number of Bearing Bars	32	33	34	35	36	37	38	39							
Panel Width	29-1/4"	30-3/16"	31-1/8"	32-1/16"	33"	33-15/16"	34-7/8"	35-13/16"							

Panel widths indicated are for gratings with 3/16" thick bearing bars. For 1/8" thick bearing bars deduct 1/16" from the stated values.

■ Indicates stock panel widths.

## 11 Space (11/16") Load Table

Use this table when evaluating spans and loads for the following types of steel grating:  
**11-W-4, 11-W-2, 11-DT-4, 11-DT-2, 11-SL-4, & 11-SL-2**

Bearing Bar Size (inches)	Approx. Weight psf *	Max. Ped. Span**	Sec. Prop.*** Sx in <sup>3</sup> Ix in <sup>4</sup>	Unsupported Span																					
				2'-0"	2'-6"	3'-0"	3'-6"	4'-0"	4'-6"	5'-0"	5'-6"	6'-0"	6'-6"	7'-0"	8'-0"	9'-0"									
3/4 x 3/16	9.1	4'-4"	0.307 0.115	U	921	589	409	301	230	182	147	All loads and deflections are theoretical and based upon the gross sections of the bearing bars, using a fiber stress of 18,000 psi.  The values are not intended to be absolute since the actual load capacity will be affected by the slight variations in mill and manufacturing tolerances.  Grating for spans to the left of the heavy line have a deflection $\leq 1/4"$ for uniform loads of 100 psf.  U = uniform load in pounds/sq. ft. C = concentrated load in pounds/ft. of grating width D = deflection in inches													
				D	0.099	0.155	0.223	0.304	0.397	0.503	0.621														
				C	921	736	614	526	460	409	368														
				D	0.079	0.124	0.179	0.243	0.318	0.402	0.497														
1 x 1/8	8.1	4'-11"	0.364 0.182	U	1,091	698	485	356	273	216	175							144							
				D	0.074	0.116	0.168	0.228	0.298	0.377	0.466							0.563							
				C	1,091	873	727	623	546	485	436														
				D	0.060	0.093	0.134	0.182	0.238	0.302	0.372							0.451							
1 x 3/16	11.9	5'-5"	0.545 0.273	U	1,636	1,047	727	534	409	323	262							216	182						
				D	0.074	0.116	0.168	0.228	0.298	0.377	0.466							0.563							
				C	1,636	1,309	1,091	935	818	727	655							595	546						
				D	0.060	0.093	0.134	0.182	0.238	0.302	0.372							0.451	0.536						
1-1/4 x 1/8	10.0	5'-9"	0.568 0.355	U	1,705	1,091	758	557	426	337	273							225	189	161					
				D	0.060	0.093	0.134	0.182	0.238	0.302	0.372	0.451	0.536	0.629											
				C	1,705	1,364	1,136	974	852	758	682	620	568	525											
				D	0.048	0.074	0.107	0.146	0.191	0.241	0.298	0.360	0.429	0.504											
1-1/4 x 3/16	14.7	6'-5"	0.852 0.533	U	2,557	1,636	1,136	835	639	505	409	338	284	242	209										
				D	0.060	0.093	0.134	0.182	0.238	0.302	0.372	0.451	0.536	0.629	0.730										
				C	2,557	2,046	1,705	1,461	1,278	1,136	1,023	930	852	787	731										
				D	0.048	0.074	0.107	0.146	0.191	0.241	0.298	0.360	0.429	0.504	0.584										
1-1/2 x 1/8	11.9	6'-8"	0.818 0.614	U	2,455	1,571	1,091	802	614	485	393	325	273	232	200	153									
				D	0.050	0.078	0.112	0.152	0.199	0.251	0.310	0.376	0.447	0.524	0.608	0.794									
				C	2,455	1,964	1,636	1,403	1,227	1,091	982	893	818	755	701	614									
				D	0.040	0.062	0.089	0.122	0.159	0.201	0.248	0.300	0.358	0.420	0.487	0.636									
1-1/2 x 3/16	17.7	7'-4"	1.227 0.920	U	3,682	2,356	1,636	1,202	921	727	589	487	409	349	301	230	182								
				D	0.050	0.078	0.112	0.152	0.199	0.251	0.310	0.376	0.447	0.524	0.608	0.794	1.006								
				C	3,682	2,946	2,455	2,104	1,841	1,636	1,473	1,339	1,227	1,133	1,052	921	818								
				D	0.040	0.062	0.089	0.122	0.159	0.201	0.248	0.300	0.358	0.420	0.487	0.636	0.804								
1-3/4 x 1/8	13.9	7'-5"	1.114 0.974	U	3,341	2,138	1,485	1,091	835	660	535	442	371	316	273	209	165								
				D	0.043	0.067	0.096	0.130	0.170	0.215	0.266	0.322	0.383	0.450	0.521	0.681	0.862								
				C	3,341	2,673	2,227	1,909	1,671	1,485	1,336	1,215	1,114	1,028	955	835	742								
				D	0.034	0.053	0.077	0.104	0.136	0.172	0.213	0.257	0.306	0.360	0.417	0.545	0.689								
1-3/4 x 3/16	20.5	8'-3"	1.670 1.462	U	5,011	3,207	2,227	1,636	1,253	990	802	663	557	474	409	313	248								
				D	0.043	0.067	0.096	0.130	0.170	0.215	0.266	0.322	0.383	0.450	0.521	0.681	0.862								
				C	5,011	4,009	3,341	2,864	2,506	2,227	2,005	1,822	1,671	1,542	1,432	1,253	1,114								
				D	0.034	0.053	0.077	0.104	0.136	0.172	0.213	0.257	0.306	0.360	0.417	0.545	0.689								
2 x 1/8	15.8	8'-3"	1.455 1.455	U	4,364	2,793	1,939	1,425	1,091	862	698	577	485	413	356	273	216								
				D	0.037	0.058	0.084	0.114	0.149	0.189	0.233	0.282	0.335	0.393	0.456	0.596	0.754								
				C	4,364	3,491	2,909	2,494	2,182	1,939	1,746	1,587	1,455	1,343	1,247	1,091	970								
				D	0.030	0.047	0.067	0.091	0.119	0.151	0.186	0.225	0.268	0.315	0.365	0.477	0.603								
2 x 3/16	23.3	9'-1"	2.182 2.182	U	6,546	4,189	2,909	2,137	1,636	1,293	1,047	866	727	620	534	409	323								
				D	0.037	0.058	0.084	0.114	0.149	0.189	0.233	0.282	0.335	0.393	0.456	0.596	0.754								
				C	6,546	5,236	4,364	3,740	3,273	2,909	2,618	2,380	2,182	2,014	1,870	1,636	1,455								
				D	0.030	0.047	0.067	0.091	0.119	0.151	0.186	0.225	0.268	0.315	0.365	0.477	0.603								
2-1/4 x 3/16	26.1	10'-0"	2.761 3.107	U	8,284	5,302	3,682	2,705	2,071	1,636	1,326	1,095	921	784	676	518	409								
				D	0.033	0.052	0.074	0.101	0.132	0.168	0.207	0.250	0.298	0.350	0.406	0.530	0.670								
				C	8,284	6,627	5,523	4,734	4,142	3,682	3,314	3,012	2,761	2,549	2,367	2,071	1,841								
				D	0.026	0.041	0.060	0.081	0.106	0.134	0.166	0.200	0.238	0.280	0.324	0.424	0.536								
2-1/2 x 3/16	28.9	10'-9"	3.409 4.261	U	10,227	6,546	4,546	3,340	2,557	2,020	1,636	1,352	1,136	968	835	639	505								
				D	0.030	0.047	0.067	0.091	0.119	0.151	0.186	0.225	0.268	0.315	0.365	0.477	0.603								
				C	10,227	8,182	6,818	5,844	5,114	4,546	4,091	3,719	3,409	3,147	2,922	2,557	2,273								
				D	0.024	0.037	0.054	0.073	0.095	0.121	0.149	0.180	0.215	0.252	0.292	0.381	0.483								

\* Weight per square foot based upon 11-W-4 grating. Add .60 psf for 2" on center cross bars. \*\* Maximum pedestrian load is defined as a 100# uniform load with deflection  $\leq 1/4$  inch. (The  $1/4"$  maximum deflection criteria is considered consistent with pedestrian comfort, but may be exceeded for other loading conditions at the discretion of the specifying authority.) \*\*\* Section properties per foot of width.

Note: When gratings with serrated surface are specified, the depth of the grating required for a specific load will be  $1/4"$  greater than that shown in these tables.

### Panel Widths

Grating panels are available from stock in nominal 24" and 36" widths. When considering alternative widths, consult this table to select widths that will maintain uniform "out-to-out" spacing of the bearing bars. Specified widths deviating from this table will be fabricated to size with side banding and the bar spacing on one side of the finished panel will vary from the spacing throughout the remainder of the panel.

Number of Bearing Bars	2	3	4	5	6	7	8	9	10	11	12	13	14	15	16
Panel Width	7/8"	1-9/16"	2-1/4"	2-15/16"	3-5/8"	4-5/16"	5"	5-11/16"	6-3/8"	7-1/16"	7-3/4"	8-7/16"	9-1/8"	9-13/16"	10-1/2"
Number of Bearing Bars	17	18	19	20	21	22	23	24	25	26	27	28	29	30	31
Panel Width	11-3/16"	11-7/8"	12-9/16"	13-1/4"	13-15/16"	14-5/8"	15-5/16"	16"	16-11/16"	17-3/8"	18-1/16"	18-3/4"	19-7/16"	20-1/8"	20-13/16"
Number of Bearing Bars	32	33	34	35	36	37	38	39	40	41	42	43	44	45	46
Panel Width	21-1/2"	22-3/16"	22-7/8"	23-9/16"	24-1/4"	24-15/16"	25-5/8"	26-5/16"	27"	27-11/16"	28-3/8"	29-1/16"	29-3/4"	30-7/16"	31-1/8"
Number of Bearing Bars	47	48	49	50	51	52	53								
Panel Width	31-13/16"	32-1/2"	33-3/16"	33-7/8"	34-9/16"	35-1/4"	35-15/16"								

Panel widths indicated are for gratings with 3/16" thick bearing bars. For 1/8" thick bearing bars deduct 1/16" from the stated values.

█ Indicates stock panel widths.

## 8 Space (1/2") Load Table

Use this table when evaluating spans and loads for the following types of steel grating:  
**8-W-4, 8-W-2, 8-DT-4, 8-DT-2, 8-SL-4, & 8-SL-2**

Bearing Bar Size (inches)	Approx. Weight psf *	Max. Ped. Span**	Sec. Prop.*** Sx in <sup>3</sup> Ix in <sup>4</sup>	Unsupported Span																																	
				2'-0"	2'-6"	3'-0"	3'-6"	4'-0"	4'-6"	5'-0"	5'-6"	6'-0"	6'-6"	7'-0"	8'-0"	9'-0"																					
3/4 x 3/16	12.3	4'-9"	0.422 0.158	U	1,266	810	563	413	316	250	203	167	All loads and deflections are theoretical and based upon the gross sections of the bearing bars, using a fiber stress of 18,000 psi. The values are not intended to be absolute since the actual load capacity will be affected by the slight variations in mill and manufacturing tolerances. Grating for spans to the left of the heavy line have a deflection ≤ 1/4" for uniform loads of 100 psf.																								
				D	0,099	0,155	0,223	0,304	0,397	0,503	0,621	0,751																									
				C	1,266	1,013	844	723	633	563	506	460																									
				D	0,079	0,124	0,179	0,243	0,318	0,402	0,497	0,601																									
1 x 1/8	11.0	5'-3"	0.500 0.250	U	1,500	960	667	490	375	296	240	198						167	U = uniform load in pounds/sq. ft. C = concentrated load pounds/ft. of grating width D = deflection in inches																		
				D	0,074	0,116	0,168	0,228	0,298	0,377	0,466	0,563						0,670																			
				C	1,500	1,200	1,000	857	750	667	600	546						500																			
				D	0,060	0,093	0,134	0,182	0,238	0,302	0,372	0,451						0,536																			
1 x 3/16	16.2	5'-10"	0.750 0.375	U	2,250	1,440	1,000	735	563	444	360	298						250						213	U = uniform load in pounds/sq. ft. C = concentrated load pounds/ft. of grating width D = deflection in inches												
				D	0,074	0,116	0,168	0,228	0,298	0,377	0,466	0,563						0,670						0,787													
				C	2,250	1,800	1,500	1,286	1,125	1,000	900	818						750						692													
				D	0,060	0,093	0,134	0,182	0,238	0,302	0,372	0,451						0,536						0,629													
1-1/4 x 1/8	13.6	6'-3"	0.781 0.488	U	2,344	1,500	1,042	765	586	463	375	310						260						222						191	U = uniform load in pounds/sq. ft. C = concentrated load pounds/ft. of grating width D = deflection in inches						
				D	0,060	0,093	0,134	0,182	0,238	0,302	0,372	0,451						0,536						0,629						0,730							
				C	2,344	1,875	1,563	1,339	1,172	1,042	938	852						781						721						670							
				D	0,048	0,074	0,107	0,146	0,191	0,241	0,298	0,360						0,429						0,504						0,584							
1-1/4 x 3/16	20.0	6'-11"	1.172 0.732	U	3,516	2,250	1,563	1,148	879	694	563	465	391	333	287	220	U = uniform load in pounds/sq. ft. C = concentrated load pounds/ft. of grating width D = deflection in inches																				
				D	0,060	0,093	0,134	0,182	0,238	0,302	0,372	0,451	0,536	0,629	0,730	0,953																					
				C	3,516	2,813	2,344	2,009	1,758	1,563	1,406	1,278	1,172	1,082	1,005	879																					
				D	0,048	0,074	0,107	0,146	0,191	0,241	0,298	0,360	0,429	0,504	0,584	0,763																					
1-1/2 x 1/8	16.2	7'-2"	1.125 0.844	U	3,375	2,160	1,500	1,102	844	667	540	446	375	320	276	211						U = uniform load in pounds/sq. ft. C = concentrated load pounds/ft. of grating width D = deflection in inches															
				D	0,050	0,078	0,112	0,152	0,199	0,251	0,310	0,376	0,447	0,524	0,608	0,794																					
				C	3,375	2,700	2,250	1,929	1,688	1,500	1,350	1,227	1,125	1,039	964	844																					
				D	0,040	0,062	0,089	0,122	0,159	0,201	0,248	0,300	0,358	0,420	0,487	0,636																					
1-1/2 x 3/16	24.0	7'-11"	1.688 1.266	U	5,063	3,240	2,250	1,653	1,266	1,000	810	669	563	479	413	316											250	U = uniform load in pounds/sq. ft. C = concentrated load pounds/ft. of grating width D = deflection in inches									
				D	0,050	0,078	0,112	0,152	0,199	0,251	0,310	0,376	0,447	0,524	0,608	0,794											1,006										
				C	5,063	4,050	3,375	2,893	2,531	2,250	2,025	1,841	1,688	1,558	1,446	1,266											1,125										
				D	0,040	0,062	0,089	0,122	0,159	0,201	0,248	0,300	0,358	0,420	0,487	0,636											0,804										
1-3/4 x 1/8	18.9	8'-1"	1.531 1.340	U	4,594	2,940	2,042	1,500	1,148	907	735	607	510	435	375	287											227						U = uniform load in pounds/sq. ft. C = concentrated load pounds/ft. of grating width D = deflection in inches				
				D	0,043	0,067	0,096	0,130	0,170	0,215	0,266	0,322	0,383	0,450	0,521	0,681											0,862										
				C	4,594	3,675	3,063	2,625	2,297	2,042	1,838	1,671	1,531	1,414	1,313	1,148											1,021										
				D	0,034	0,053	0,077	0,104	0,136	0,172	0,213	0,257	0,306	0,360	0,417	0,545											0,689										
1-3/4 x 3/16	27.9	8'-11"	2.297 2.010	U	6,891	4,410	3,063	2,250	1,723	1,361	1,103	911	766	652	563	431	340	U = uniform load in pounds/sq. ft. C = concentrated load pounds/ft. of grating width D = deflection in inches																			
				D	0,043	0,067	0,096	0,130	0,170	0,215	0,266	0,322	0,383	0,450	0,521	0,681	0,862																				
				C	6,891	5,513	4,594	3,938	3,445	3,063	2,756	2,506	2,297	2,120	1,969	1,723	1,531																				
				D	0,034	0,053	0,077	0,104	0,136	0,172	0,213	0,257	0,306	0,360	0,417	0,545	0,689																				
2 x 1/8	21.5	8'-11"	2.000 2.000	U	6,000	3,840	2,667	1,959	1,500	1,185	960	793	667	568	490	375	296						U = uniform load in pounds/sq. ft. C = concentrated load pounds/ft. of grating width D = deflection in inches														
				D	0,037	0,058	0,084	0,114	0,149	0,189	0,233	0,282	0,335	0,393	0,456	0,596	0,754																				
				C	6,000	4,800	4,000	3,429	3,000	2,667	2,400	2,182	2,000	1,846	1,714	1,500	1,333																				
				D	0,030	0,047	0,067	0,091	0,119	0,151	0,186	0,225	0,268	0,315	0,365	0,477	0,603																				
2 x 3/16	31.8	9'-11"	3.000 3.000	U	9,000	5,760	4,000	2,939	2,250	1,778	1,440	1,190	1,000	852	735	563	444											U = uniform load in pounds/sq. ft. C = concentrated load pounds/ft. of grating width D = deflection in inches									
				D	0,037	0,058	0,084	0,114	0,149	0,189	0,233	0,282	0,335	0,393	0,456	0,596	0,754																				
				C	9,000	7,200	6,000	5,143	4,500	4,000	3,600	3,273	3,000	2,769	2,571	2,250	2,000																				
				D	0,030	0,047	0,067	0,091	0,119	0,151	0,186	0,225	0,268	0,315	0,365	0,477	0,603																				
2-1/4 x 3/16	35.7	10'-10"	3.797 4.271	U	11,391	7,290	5,063	3,719	2,848	2,250	1,823	1,506	1,266	1,078	930	712	563																U = uniform load in pounds/sq. ft. C = concentrated load pounds/ft. of grating width D = deflection in inches				
				D	0,033	0,052	0,074	0,101	0,132	0,168	0,207	0,250	0,298	0,350	0,406	0,530	0,670																				
				C	11,391	9,113	7,594	6,509	5,695	5,063	4,556	4,142	3,797	3,505	3,255	2,848	2,531																				
				D	0,026	0,041	0,060	0,081	0,106	0,134	0,166	0,200	0,238	0,280	0,324	0,424	0,536																				
2-1/2 x 3/16	39.6	11'-8"	4.688 5.859	U	14,063	9,000	6,250	4,592	3,516	2,778	2,250	1,860	1,563	1,331	1,148	879	694	U = uniform load in pounds/sq. ft. C = concentrated load pounds/ft. of grating width D = deflection in inches																			
				D	0,030	0,047	0,067	0,091	0,119	0,151	0,186	0,225	0,268	0,315	0,365	0,477	0,603																				
				C	14,063	11,250	9,375	8,036	7,031	6,250	5,625	5,114	4,688	4,327	4,018	3,516	3,125																				
				D	0,024	0,037	0,054	0,073	0,095	0,121	0,149	0,180	0,215	0,252	0,292	0,381	0,483																				

\* Weight per square foot based upon 8-W-4 grating. Add .60 psf for 2" on center cross bars. \*\* Maximum pedestrian load is defined as a 100# uniform load with deflection ≤ 1/4 inch. (The 1/4" maximum deflection criteria is considered consistent with pedestrian comfort, but may be exceeded for other loading conditions at the discretion of the specifying authority.) \*\*\* Section properties per foot of width.

Welded grating types 8-W-4 and 8-W-2 are available in bearing bar depths from 3/4" to 1-1/2".

Note: When gratings with serrated surface are specified, the depth of the grating required for a specific load will be 1/4" greater than that shown in these tables.

### Panel Widths

Grating panels are available from stock in nominal 24" and 36" widths. When considering alternative widths, consult this table to select widths that will maintain uniform "out-to-out" spacing of the bearing bars. Specified widths deviating from this table will be fabricated to size with side banding and the bar spacing on one side of the finished panel will vary from the spacing throughout the remainder of the panel.

Number of Bearing Bars	2	3	4	5	6	7	8	9	10	11	12	13	14	15	16
Panel Width	11-1/16"	1-3/16"	1-11/16"	2-3/16"	2-11/16"	3-3/16"	3-11/16"	4-3/16"	4-11/16"	5-3/16"	5-11/16"	6-3/16"	6-11/16"	7-3/16"	7-11/16"
Number of Bearing Bars	17	18	19	20	21	22	23	24	25	26	27	28	29	30	31
Panel Width	8-3/16"	8-11/16"	9-3/16"	9-11/16"	10-3/16"	10-11/16"	11-3/16"	11-11/16"	12-3/16"	12-11/16"	13-3/16"	13-11/16"	14-3/16"	14-11/16"	15-3/16"
Number of Bearing Bars	32	33	34	35	36	37	38	39	40	41	42	43	44	45	46
Panel Width	15-11/16"	16-3/16"	16-11/16"	17-3/16"	17-11/16"	18-3/16"	18-11/16"	19-3/16"	19-11/16"	20-3/16"	20-11/16"	21-3/16"	21-11/16"	22-3/16"	22-11/16"
Number of Bearing Bars	47	48	49	50	51	52	53	54	55	56	57	58	59	60	61
Panel Width	23-3/16"	23-11/16"	24-3/16"	24-11/16"	25-3/16"	25-11/16"	26-3/16"	26-11/16"	27-3/16"	27-11/16"	28-3/16"	28-11/16"	29-3/16"	29-11/16"	30-3/16"
Number of Bearing Bars	62	63	64	65	66	67	68	69	70	71	72				
Panel Width	30-11/16"	31-3/16"	31-11/16"	32-3/16"	32-11/16"	33-3/16"	33-11/16"	34-3/16"	34-11/16"	35-3/16"	35-11/16"				

Panel widths indicated are for gratings with 3/16" thick bearing bars. For 1/8" thick bearing bars deduct 1/16" from the stated values.

■ Indicates stock panel widths.

# Steel Bar Grating

## 7 Space (7/16") Load Table

Use this table when evaluating spans and loads for the following types of steel grating:  
**7-W-4, 7-W-2, 7-DT-4, 7-DT-2, 7-SL-4, & 7-SL-2**

Bearing Bar Size (inches)	Approx. Weight psf *	Max. Ped. Span**	Sec. Prop.*** Sx in <sup>3</sup> Ix in <sup>4</sup>	Unsupported Span																					
				2'-0"	2'-6"	3'-0"	3'-6"	4'-0"	4'-6"	5'-0"	5'-6"	6'-0"	6'-6"	7'-0"	8'-0"	9'-0"									
3/4 x 3/16	13.9	4'-10"	0.482 0.181	U	1,446	926	643	472	362	286	231	191	All loads and deflections are theoretical and based upon the gross sections of the bearing bars, using a fiber stress of 18,000 psi. The values are not intended to be absolute since the actual load capacity will be affected by the slight variations in mill and manufacturing tolerances. Grating for spans to the left of the heavy line have a deflection ≤ 1/4" for uniform loads of 100 pst. U = uniform load in pounds/sq. ft. C = concentrated load in pounds/ft. of grating width D = deflection in inches												
				D	0.099	0.155	0.223	0.304	0.397	0.503	0.621	0.751													
				C	1,446	1,157	964	827	723	643	579	526													
				D	0.079	0.124	0.179	0.243	0.318	0.402	0.497	0.601													
1 x 1/8	12.4	5'-6"	0.571 0.286	U	1,714	1,097	762	560	429	339	274	227						191	243	219	251	286	286		
				D	0.074	0.116	0.168	0.228	0.298	0.377	0.466	0.563						0.670	0.787	0.904	1,021	1,138	1,255	1,372	
				C	1,714	1,371	1,143	980	857	762	686	623						571	536	501	466	431	396	361	326
				D	0.060	0.093	0.134	0.182	0.238	0.302	0.372	0.451						0.536	0.629	0.722	0.815	0.908	1,001	1,094	1,187
1 x 3/16	18.3	6'-1"	0.857 0.429	U	2,571	1,646	1,143	840	643	508	411	340						286	243	219	251	286	286		
				D	0.074	0.116	0.168	0.228	0.298	0.377	0.466	0.563						0.670	0.787	0.904	1,021	1,138	1,255	1,372	
				C	2,571	2,057	1,714	1,469	1,286	1,143	1,029	935						857	791	725	659	593	527	461	395
				D	0.060	0.093	0.134	0.182	0.238	0.302	0.372	0.451						0.536	0.629	0.722	0.815	0.908	1,001	1,094	1,187
1-1/4 x 1/8	15.3	6'-6"	0.893 0.558	U	2,679	1,714	1,191	875	670	529	429	354						298	254	219	251	286	286		
				D	0.060	0.093	0.134	0.182	0.238	0.302	0.372	0.451	0.536	0.629	0.722	0.815	0.908	1,001	1,094						
				C	2,679	2,143	1,786	1,531	1,339	1,191	1,071	974	893	824	765	706	647	588	529	470					
				D	0.048	0.074	0.107	0.146	0.191	0.241	0.298	0.360	0.429	0.504	0.584	0.664	0.744	0.824	0.904	0.984					
1-1/4 x 3/16	22.7	7'-2"	1.339 0.837	U	4,018	2,571	1,786	1,312	1,005	794	643	531	446	380	328	286	251	286							
				D	0.060	0.093	0.134	0.182	0.238	0.302	0.372	0.451	0.536	0.629	0.722	0.815	0.908	1,001	1,094						
				C	4,018	3,214	2,679	2,296	2,009	1,786	1,607	1,461	1,339	1,236	1,148	1,060	972	884	796	708					
				D	0.048	0.074	0.107	0.146	0.191	0.241	0.298	0.360	0.429	0.504	0.584	0.664	0.744	0.824	0.904	0.984					
1-1/2 x 1/8	18.3	7'-5"	1.286 0.964	U	3,857	2,469	1,714	1,260	964	762	617	510	429	365	315	241	286	286							
				D	0.050	0.078	0.112	0.152	0.199	0.251	0.310	0.376	0.447	0.524	0.608	0.704	0.800	0.896	0.992						
				C	3,857	3,086	2,571	2,204	1,929	1,714	1,543	1,403	1,286	1,187	1,102	1,027	952	877	802	727					
				D	0.040	0.062	0.089	0.122	0.159	0.201	0.248	0.300	0.358	0.420	0.487	0.554	0.621	0.688	0.755	0.822					
1-1/2 x 3/16	27.2	8'-3"	1.929 1.446	U	5,786	3,703	2,571	1,889	1,446	1,143	926	765	643	548	472	362	286	286							
				D	0.050	0.078	0.112	0.152	0.199	0.251	0.310	0.376	0.447	0.524	0.608	0.704	0.800	0.896	0.992						
				C	5,786	4,629	3,857	3,306	2,893	2,571	2,314	2,104	1,929	1,780	1,653	1,546	1,446	1,346	1,246	1,146					
				D	0.040	0.062	0.089	0.122	0.159	0.201	0.248	0.300	0.358	0.420	0.487	0.554	0.621	0.688	0.755	0.822					
1-3/4 x 1/8	21.3	8'-4"	1.750 1.531	U	5,250	3,360	2,333	1,714	1,313	1,037	840	694	583	497	429	328	259	286							
				D	0.043	0.067	0.096	0.130	0.170	0.215	0.266	0.322	0.383	0.450	0.521	0.681	0.862	1,043	1,224						
				C	5,250	4,200	3,500	3,000	2,625	2,333	2,100	1,909	1,750	1,615	1,500	1,313	1,167	1,021	875	729					
				D	0.034	0.053	0.077	0.104	0.136	0.172	0.213	0.257	0.306	0.360	0.417	0.474	0.531	0.588	0.645	0.702					
1-3/4 x 3/16	31.6	9'-3"	2.625 2.297	U	7,875	5,040	3,500	2,571	1,969	1,556	1,260	1,041	875	746	643	492	389	286							
				D	0.043	0.067	0.096	0.130	0.170	0.215	0.266	0.322	0.383	0.450	0.521	0.681	0.862	1,043	1,224						
				C	7,875	6,300	5,250	4,500	3,938	3,500	3,150	2,864	2,625	2,423	2,250	1,969	1,750	1,531	1,313	1,094					
				D	0.034	0.053	0.077	0.104	0.136	0.172	0.213	0.257	0.306	0.360	0.417	0.474	0.531	0.588	0.645	0.702					
2 x 1/8	24.3	9'-3"	2.286 2.286	U	6,857	4,389	3,048	2,239	1,714	1,355	1,097	907	762	649	560	429	339	286							
				D	0.037	0.058	0.084	0.114	0.149	0.189	0.233	0.282	0.335	0.393	0.456	0.596	0.754	0.912	1,070						
				C	6,857	5,486	4,571	3,918	3,429	3,048	2,743	2,494	2,286	2,110	1,959	1,714	1,524	1,334	1,144	954					
				D	0.030	0.047	0.067	0.091	0.119	0.151	0.186	0.225	0.268	0.315	0.365	0.417	0.477	0.537	0.597	0.657					
2 x 3/16	36.0	10'-3"	3.429 3.429	U	10,286	6,583	4,571	3,359	2,571	2,032	1,646	1,360	1,143	974	840	643	508	286							
				D	0.037	0.058	0.084	0.114	0.149	0.189	0.233	0.282	0.335	0.393	0.456	0.596	0.754	0.912	1,070						
				C	10,286	8,229	6,857	5,878	5,143	4,571	4,114	3,740	3,429	3,165	2,939	2,571	2,286	1,969	1,750	1,531					
				D	0.030	0.047	0.067	0.091	0.119	0.151	0.186	0.225	0.268	0.315	0.365	0.417	0.477	0.537	0.597	0.657					
2-1/4 x 3/16	40.5	11'-2"	4.339 4.882	U	13,018	8,331	5,786	4,251	3,255	2,571	2,083	1,721	1,446	1,233	1,063	814	643	286							
				D	0.033	0.052	0.074	0.101	0.132	0.168	0.207	0.250	0.298	0.350	0.406	0.530	0.670	0.810	0.950						
				C	13,018	10,414	8,679	7,439	6,509	5,786	5,207	4,734	4,339	4,006	3,719	3,255	2,893	2,531	2,169	1,807					
				D	0.026	0.041	0.060	0.081	0.106	0.134	0.166	0.200	0.238	0.280	0.324	0.424	0.536	0.648	0.760	0.872					
2-1/2 x 3/16	44.9	12'-1"	5.357 6.696	U	16,071	10,286	7,143	5,248	4,018	3,175	2,571	2,125	1,786	1,522	1,312	1,005	794	286							
				D	0.030	0.047	0.067	0.091	0.119	0.151	0.186	0.225	0.268	0.315	0.365	0.477	0.603	0.729	0.855						
				C	16,071	12,857	10,714	9,184	8,036	7,143	6,429	5,844	5,357	4,945	4,592	4,018	3,571	3,124	2,677	2,230					
				D	0.024	0.037	0.054	0.073	0.095	0.121	0.149	0.180	0.215	0.252	0.292	0.381	0.483	0.585	0.687	0.789					

\* Weight per square foot based upon 7-W-4 grating. Add .60 psf for 2" on center cross bars. \*\* Maximum pedestrian load is defined as a 100# uniform load with deflection ≤ 1/4 inch. (The 1/4" maximum deflection criteria is considered consistent with pedestrian comfort, but may be exceeded for other loading conditions at the discretion of the specifying authority.) \*\*\* Section properties per foot of width.

Welded grating types 7-W-4 and 7-W-2 are available in bearing bar depths from 3/4" to 1-1/2".

Note: When gratings with serrated surface are specified, the depth of the grating required for a specific load will be 1/4" greater than that shown in these tables.

### Panel Widths

Grating panels are available from stock in nominal 24" and 36" widths. When considering alternative widths, consult this table to select widths that will maintain uniform "out-to-out" spacing of the bearing bars. Specified widths deviating from this table will be fabricated to size with side banding and the bar spacing on one side of the finished panel will vary from the spacing throughout the remainder of the panel.

Number of Bearing Bars Panel Width	2 5/8"	3 1-1/16"	4 1-1/2"	5 1-15/16"	6 2-3/8"	7 2-13/16"	8 3-1/4"	9 3-11/16"	10 4-1/8"	11 4-9/16"	12 5"	13 5-7/16"	14 5-7/8"	15 6-5/16"	16 6-3/4"
Number of Bearing Bars Panel Width	17 7-3/16"	18 7-5/8"	19 8-1/16"	20 8-1/2"	21 8-15/16"	22 9-3/8"	23 9-13/16"	24 10-1/4"	25 10-11/16"	26 11-1/8"	27 11-9/16"	28 12"	29 12-7/16"	30 12-7/8"	31 13-5/16"
Number of Bearing Bars Panel Width	32 13-3/4"	33 14-3/16"	34 14-5/8"	35 15-1/16"	36 15-1/2"	37 15-15/16"	38 16-3/8"	39 16-13/16"	40 17-1/4"	41 17-11/16"	42 18-1/8"	43 18-9/16"	44 19-7/16"	45 19-7/8"	46 19-7/8"
Number of Bearing Bars Panel Width	47 20-5/16"	48 20-3/4"	49 21-3/16"	50 21-5/8"	51 22-1/16"	52 22-1/2"	53 22-15/16"	54 23-3/8"	55 23-13/16"	56 24-1/4"	57 24-11/16"	58 25-1/8"	59 25-9/16"	60 26"	61 26-7/16"
Number of Bearing Bars Panel Width	62 26-7/8"	63 27-5/16"	64 27-3/4"	65 28-3/16"	66 28-5/8"	67 29-1/16"	68 29-1/2"	69 29-15/16"	70 30-3/8"	71 30-13/16"	72 31-1/4"	73 31-11/16"	74 32-1/8"	75 32-9/16"	76 33"
Number of Bearing Bars Panel Width	77 33-7/16"	78 33-7/8"	79 34-5/16"	80 34-3/4"	81 35-3/16"	82 35-5/8"	83 36-1/16"								

Panel widths indicated are for gratings with 3/16" thick bearing bars. For 1/8" thick bearing bars deduct 1/16" from the stated values.

■ Indicates stock panel widths.

## Steel Stair Treads

Steel grating stair treads are available fabricated to any size in type "W" welded, type "DT" dovetail pressure locked, or type "SL" swage locked grating. Treads are manufactured with a defined visible nosing and pre-punched end carrier plates or angles, ready for bolting or welding to the stair stringers.



## Steel Carrier Plates & Angles

### Steel Carrier Plates

Recommended for use with 19, 15, and 11 spaced gratings

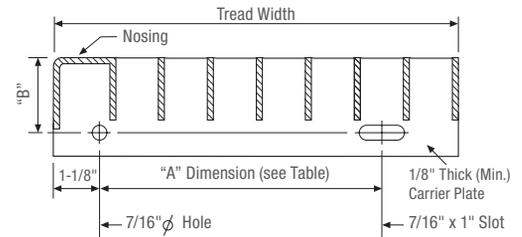

"B" Dimension

- 1-3/4" for 3/4" thru 1-1/4" bearing bars
- 2-1/4" for 1-1/2" thru 1-3/4" bearing bars
- 3-1/4" for 2" thru 2-1/2" bearing bars

### Steel Carrier Angles

Recommended for use with 8 and 7 spaced gratings

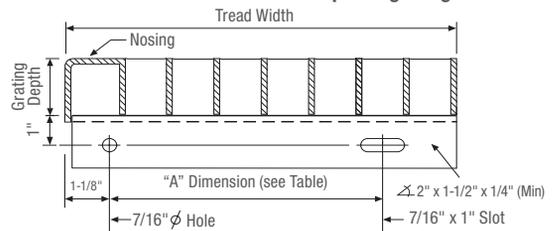

### Nosing Options



Checker plate nosing welded to grating and carrier plates/angles.

Cast abrasive nosing mechanically fastened to welded mounting angle.

Algrid nosing welded to grating and carrier plates/angles.

Table of Stair Tread Widths

19 Space			15 Space			11 Space			8 Space			7 Space		
Bearing Bars @ 1-3/16" O.C.			Bearing Bars @ 15/16" O.C.			Bearing Bars @ 11/16" O.C.			Bearing Bars @ 1/2" O.C.			Bearing Bars @ 7/16" O.C.		
Nominal Tread Width	Number of Bearing Bars	Standard "A" Dimension	Nominal Tread Width	Number of Bearing Bars	Standard "A" Dimension	Nominal Tread Width	Number of Bearing Bars	Standard "A" Dimension	Nominal Tread Width	Number of Bearing Bars	Standard "A" Dimension	Nominal Tread Width	Number of Bearing Bars	Standard "A" Dimension
6-1/4"	5	2-1/2"	7"	7	4-1/2"	6-1/4"	8	2-1/2"	6-1/2"	11	2-1/2"	6-3/4"	13	2-1/2"
7-3/8"	6	4-1/2"	8"	8	4-1/2"	7-5/8"	10	4-1/2"	7-1/2"	13	4-1/2"	7-5/8"	15	4-1/2"
8-1/2"	7	4-1/2"	8-7/8"	9	4-1/2"	9"	12	4-1/2"	9"	16	4-1/2"	8-1/2"	17	4-1/2"
9-3/4"	8	7"	9-7/8"	10	7"	10-3/8"	14	7"	10"	18	7"	10-1/8"	21	7"
11"	9	7"	10-3/4"	11	7"	11"	15	7"	11"	20	7"	11-1/8"	23	7"
12-1/8"	10	7"	11-5/8"	12	7"	11-3/4"	16	7"	12"	22	7"	12"	25	7"

Recommended Maximum Steel Stair Tread Lengths\*

Bearing Bar Size	19 Space		15 Space		11 Space		8 Space		7 Space	
	1-3/16" O.C.		15/16" O.C.		11/16" O.C.		1/2" O.C.		7/16" O.C.	
	Plain	Serrated	Plain	Serrated	Plain	Serrated	Plain	Serrated	Plain	Serrated
3/4" x 3/16"	2'-4"	—	2'-8"	—	3'-1"	—	3'-7"	—	3'-10"	—
1" x 3/16"	3'-5"	2'-10"	4'-0"	3'-4"	4'-3"	3'-9"	4'-9"	4'-1"	5'-2"	4'-5"
1-1/4" x 3/16"	4'-8"	4'-2"	5'-1"	4'-6"	5'-6"	4'-10"	5'-6"	5'-5"	5'-6"	5'-6"
1-1/2" x 3/16"	5'-6"	5'-3"	5'-6"	5'-6"	5'-6"	5'-6"	5'-8"	5'-6"	5'-10"	5'-5"
1-3/4" x 3/16"	5'-6"	5'-6"	5'-8"	5'-6"	5'-11"	5'-7"	6'-6"	6'-1"	6'-9"	6'-4"
2" x 3/16"	5'-11"	5'-7"	6'-4"	6'-0"	6'-9"	6'-4"	7'-5"	6'-11"	7'-8"	7'-3"
2-1/4" x 3/16"	6'-8"	6'-3"	7'-1"	6'-9"	7'-7"	7'-2"	8'-3"	7'-10"	8'-7"	8'-2"
2-1/2" x 3/16"	7'-4"	7'-0"	7'-11"	7'-6"	8'-4"	7'-11"	9'-2"	8'-9"	9'-6"	9'-1"

\* For treads up to 5'-6", maximum tread lengths are based upon 300 lb. concentrated load on the front 5 inches of the tread, at the center of the tread length. When treads exceed 5'-6" in length, design allows for 300 lb. concentrated loads at 1/3 points of tread length. Deflection is limited to the lesser of .250" or 1/240 of tread length in all cases.

# Aluminum Bar Grating

**Aluminum Bar Grating** is lightweight, corrosion resistant, non-sparking, and has an unmatched strength-to-weight ratio. Manufactured from ASTM B221, 6063, or 6061 alloy, aluminum grating is available in four distinct products: type “SG” Swaged Rectangular Bar, type “SGI” Swaged “I”-bar, type “SGF” Swaged Flush-Top, and type “ADT” Dovetail Pressure Locked. All four products are available with bearing bar spacing ranging from 19/16" (1-3/16") to 7/16" on center and with cross bars at either 4" or 2" on center.

Aluminum products are typically shipped “mill finish” with no additional treatment. For architectural applications or highly corrosive environments, supplemental anodizing, chemical cleaning, or powder coat finishes are available.

The load tables on pages 14-18 provide detailed specification information relating to all four aluminum products.



Type  
19-SG-4

## Type “SG” Aluminum Grating

The most widely used aluminum grating, type “SG” rectangular bar, provides clean, crisp lines. Bearing bars are available with standard plain or optional serrated or Algrip surfaces. The cross bars are fully locked within the bearing bar, slightly below the top surface.

Type **19-SG-4** aluminum grating is the industry recognized standard for industrial applications. With nearly 80% open area, 19-SG-4 spacing is virtually self-cleaning, allowing for the easy passage of dirt, debris, snow, and liquids.

Type “SG” gratings are available in close mesh ADA conforming spacings 11-SG-4 and 7-SG-4 which are commonly used in public areas. When specifying type 11-SG-4 for ADA applications, 3/16" thick bearing bars must be designated.



Type  
19-SGI-4

## Type “SGI” Aluminum Grating

Manufactured with highly efficient “I” shaped extruded bearing bars, type “SGI” aluminum grating carries the same load as 3/16" thick rectangular bar type “SG” aluminum grating.

Advantages include reduced weight per square foot and the striated flanges of the “I”-bar provide enhanced skid resistance without the added cost of serration.



## Type “SGF” Swaged Flush-Top Aluminum Grating

Manufactured with a unique, extruded cross bar that is flush with the top surface of the bearing bars, type “SGF” aluminum grating provides an enhanced walking surface for areas subject to continuous pedestrian traffic.

Available in rectangular bar with plain or serrated surfaces, type “SGF” aluminum grating is also available in ADA conforming spacings for applications located in the public way.

Swaged Flush-Top  
Intersection

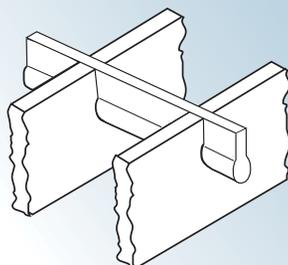

## Type “ADT” Aluminum Dovetail Pressure Locked Grating

Type “ADT” aluminum gratings have deep rectangular cross bars and are manufactured by inserting pre-punched bearing bars and cross bars into an “egg-crate” configuration and deforming the cross bars under intense hydraulic pressure.

The deep cross bars on type “ADT” gratings make them popular for architectural applications such as sun shades and infill panels with the deeper cross bar serving as a distinct visual accent.

Dovetail  
Intersection

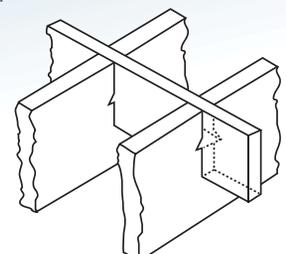

## Aluminum Grating Table of Spacings

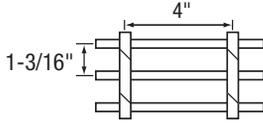
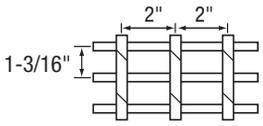
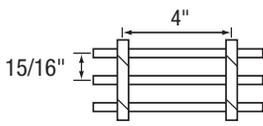
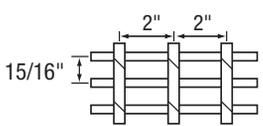
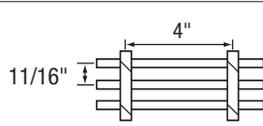
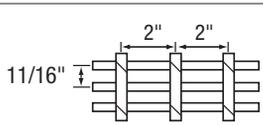
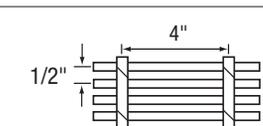
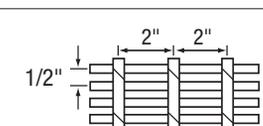
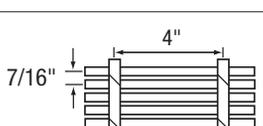
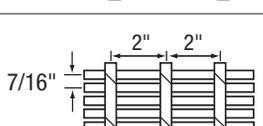
Part No.	Spacing	Open Area*	
19-SG-4 19-SGI-4 19-SGF-4 19-ADT-4		78%	Bearing bars spaced at 1-3/16" on center and cross bars at 4" on center. The workhorse of industrial flooring, popular for platforms, catwalks, mezzanines, and stairways.
19-SG-2 19-SGI-2 19-SGF-2 19-ADT-2		73%	Bearing bars spaced at 1-3/16" on center and cross bars at 2" on center. Excellent for short spans and applications where additional lateral stability is desired.
15-SG-4 15-SGI-4 15-SGF-4 15-ADT-4		75%	Bearing bars spaced at 15/16" on center and cross bars at 4" on center. The closer spaced bearing bars increase load capacity by more than 26% when compared to similar gratings produced with bearing bars at 1-3/16" on center.
15-SG-2 15-SGI-2 15-SGF-2 15-ADT-2		69%	Bearing bars spaced at 15/16" on center and cross bars at 2" on center. The closer spaced bearing bars and cross bars provide additional flooring surface to support pedestrian and wheeled traffic.
11-SG-4 11-SGI-4 11-SGF-4 11-ADT-4		68%	Bearing bars spaced at 11/16" on center and cross bars at either 4" or 2" on center. Types 11-4 and 11-2 with 3/16" thick bearing bars comply with the spacing requirements of the Americans with Disabilities Act. For ADA installations, specify that the bearing bars span perpendicular to the normal flow of traffic.
11-SG-2 11-SGI-2 11-SGF-2 11-ADT-2		63%	
8-SG-4 8-SGI-4 8-SGF-4 8-ADT-4		58%	Bearing bars spaced at 1/2" on center and cross bars at 4" or 2" on center. Types 8-4 and 8-2 comply with ADA spacing requirements. These products are popular for material handling platforms and mezzanines subject to continuous cart and dolly traffic.
8-SG-2 8-SGI-2 8-SGF-2 8-ADT-2		54%	
7-SG-4 7-SGI-4 7-SGF-4 7-ADT-4		53%	Bearing bars spaced at 7/16" on center and cross bars at 4" or 2" on center. Types 7-4 and 7-2 comply with ADA spacing requirements and are popular for applications in the public way. When specified with 3/16" thick bearing bars, 7-4 and 7-2 gratings have a net 1/4" clear opening between the bearing bars and commonly reject intrusion by high heeled shoes.
7-SG-2 7-SGI-2 7-SGF-2 7-ADT-2		49%	

\* Percentage of open area is based upon 3/16" thick bearing bars and .275" cross bars. Contact Grating Pacific if exact open area calculation is required for alternative bearing bar thicknesses or cross bar sizes.

### How to Specify Aluminum Bar Grating

- Select type of grating
  - "SG" for swaged rectangular bar grating
  - "SGI" for swaged "I"-bar grating
  - "SGF" for swaged Flush-Top grating
  - "ADT" for aluminum dovetail pressure locked grating
- Select bar spacing from table above
- Select bearing bar size (consult load tables on pages 14-18 considering service loads and clear spans)
- Specify plain, serrated, or Algrip surface
- Specify banding or additional trim required
- Specify finish
  - Mill finish (no finish)
  - Anodized (clear, bronze, other)
  - Powder coating
  - Other
- Specify fasteners (if required) – see page 59

# Aluminum Bar Grating

## 19 Space (1-3/16") Load Table

Use this table when evaluating spans and loads for the following types of aluminum grating:  
**19-SG-4, 19-SG-2, 19-SGI-4, 19-SGI-2, 19-SGF-4, 19-SGF-2,**  
**19-ADT-4, & 19-ADT-2**

Bearing Bar Size (inches)	Approx. Weight psf *	Maximum Pedestrian Span**	Sec. Prop.*** Sx in <sup>3</sup> Ix in <sup>4</sup>	Unsupported Span															
				2'-0	2'-6	3'-0	3'-6	4'-0	4'-6	5'-0	5'-6	6'-0	6'-6	7'-0	8'-0				
3/4 x 3/16	1.9	2'-11"	0.178 0.067	U	355	227	158	116											
				D	0.192	0.300	0.432	0.588											
				C	355	284	237	203											
				D	0.154	0.240	0.346	0.470											
3/4" I-Bar	1.7	3'-3"	0.211 0.105	U	421	270	187	138	105										
				D	0.144	0.225	0.324	0.441	0.576										
				C	421	337	281	241	211										
				D	0.115	0.180	0.259	0.353	0.461										
1 x 1/8	1.7	3'-8"	0.316 0.158	U	632	404	281	206	158	125									
				D	0.144	0.225	0.324	0.441	0.576	0.729									
				C	632	505	421	361	316	281									
				D	0.115	0.180	0.259	0.353	0.461	0.583									
1 x 3/16	2.5	3'-11"	0.329 0.206	U	658	421	292	215	165	130									
				D	0.115	0.180	0.259	0.353	0.461	0.583									
				C	658	526	439	376	329	292									
				D	0.092	0.144	0.207	0.282	0.369	0.467									
1-1/4 x 1/8	2.1	4'-4"	0.493 0.308	U	987	632	439	322	247	195	158	131	110						
				D	0.115	0.180	0.259	0.353	0.461	0.583	0.720	0.871	1.037						
				C	987	790	658	564	493	439	395	359	329						
				D	0.092	0.144	0.207	0.282	0.369	0.467	0.576	0.697	0.829						
1-1/4 x 3/16	3.1	4'-5"	0.474 0.355	U	947	606	421	309	237	187	152	125	105	90	77	59			
				D	0.096	0.150	0.216	0.294	0.384	0.486	0.600	0.726	0.864	1.014	1.176	1.536			
				C	947	758	632	541	474	421	379	345	316	292	271	237			
				D	0.077	0.120	0.173	0.235	0.307	0.389	0.480	0.581	0.691	0.811	0.941	1.229			
1-1/2 x 1/8	2.5	4'-11"	0.711 0.533	U	1,421	910	632	464	355	281	227	188	158	135	116	89			
				D	0.096	0.150	0.216	0.294	0.384	0.486	0.600	0.726	0.864	1.014	1.176	1.536			
				C	1,421	1,137	947	812	711	632	568	517	474	437	406	355			
				D	0.077	0.120	0.173	0.235	0.307	0.389	0.480	0.581	0.691	0.811	0.941	1.229			
1-3/4 x 1/8	2.9	5'-0"	0.645 0.564	U	1,290	825	573	421	322	255	206	171	143	122	105	81			
				D	0.082	0.129	0.185	0.252	0.329	0.417	0.514	0.622	0.741	0.869	1.008	1.317			
				C	1,290	1,032	860	737	645	573	516	469	430	397	368	322			
				D	0.066	0.103	0.148	0.202	0.263	0.333	0.411	0.498	0.592	0.695	0.806	1.053			
1-3/4 x 3/16	4.2	5'-6"	0.967 0.846	U	1,934	1,238	860	632	484	382	310	256	215	183	158	121			
				D	0.082	0.129	0.185	0.252	0.329	0.417	0.514	0.622	0.741	0.869	1.008	1.317			
				C	1,934	1,547	1,290	1,105	967	860	774	703	645	595	553	484			
				D	0.066	0.103	0.148	0.202	0.263	0.333	0.411	0.498	0.592	0.695	0.806	1.053			
2 x 1/8	3.3	5'-6"	0.842 0.842	U	1,684	1,078	749	550	421	333	270	223	187	160	138	105			
				D	0.072	0.113	0.162	0.221	0.288	0.365	0.450	0.545	0.648	0.761	0.882	1.152			
				C	1,684	1,347	1,123	962	842	749	674	612	561	518	481	421			
				D	0.058	0.090	0.130	0.176	0.230	0.292	0.360	0.436	0.518	0.608	0.706	0.922			
2 x 3/16	4.8	6'-1"	1.263 1.263	U	2,526	1,617	1,123	825	632	499	404	334	281	239	206	158			
				D	0.072	0.113	0.162	0.221	0.288	0.365	0.450	0.545	0.648	0.761	0.882	1.152			
				C	2,526	2,021	1,684	1,444	1,263	1,123	1,011	919	842	777	722	632			
				D	0.058	0.090	0.130	0.176	0.230	0.292	0.360	0.436	0.518	0.608	0.706	0.922			
2-1/4 x 3/16	5.4	6'-8"	1.599 1.799	U	3,197	2,046	1,421	1,044	799	632	512	423	355	303	261	200			
				D	0.064	0.100	0.144	0.196	0.256	0.324	0.400	0.484	0.576	0.676	0.784	1.024			
				C	3,197	2,558	2,132	1,827	1,599	1,421	1,279	1,163	1,066	984	914	799			
				D	0.051	0.080	0.115	0.157	0.205	0.259	0.320	0.387	0.461	0.541	0.627	0.819			
2-1/2 x 3/16	5.9	7'-3"	1.974 2.467	U	3,947	2,526	1,754	1,289	987	780	632	522	439	374	322	247			
				D	0.058	0.090	0.130	0.176	0.230	0.292	0.360	0.436	0.518	0.608	0.706	0.922			
				C	3,947	3,158	2,632	2,256	1,974	1,754	1,579	1,435	1,316	1,215	1,128	987			
				D	0.046	0.072	0.104	0.141	0.184	0.233	0.288	0.348	0.415	0.487	0.564	0.737			

All loads and deflections are theoretical and based upon the gross sections of the bearing bars, using a fiber stress of 12,000 psi.

The values are not intended to be absolute since the actual load capacity will be affected by the slight variations in mill and manufacturing tolerances.

Grating for spans to the left of the heavy line have a deflection  $\leq 1/4"$  for uniform loads of 100 psf.

U = uniform load in pounds/sq. ft.  
 C = concentrated load in pounds/foot of grating width  
 D = deflection in inches

\* Weight per square foot based upon 19-SG-4 grating. Add .30 psf for 2" on center cross bars. \*\* Maximum pedestrian load is defined as a 100# uniform load with deflection  $\leq 1/4$  inch. (The 1/4" maximum deflection criteria is considered consistent with pedestrian comfort, but may be exceeded for other loading conditions at the discretion of the specifying authority.) \*\*\* Section properties per foot of width.

**Note: When gratings with serrated surface are specified, the depth of the grating required for a specific load will be 1/4" greater than that shown in these tables.**

### Panel Widths

Grating panels are available from stock in nominal 24" and 36" widths. When considering alternative widths, consult this table to select widths that will maintain uniform "out-to-out" spacing of the bearing bars. Specified widths deviating from this table will be fabricated to size with side banding and the bar spacing on one side of the finished panel will vary from the spacing throughout the remainder of the panel.

Number of Bearing Bars	2	3	4	5	6	7	8	9	10	11	12	13	14	15	16
Panel Width	1-3/8"	2-9/16"	3-3/4"	4-15/16"	6-1/8"	7-5/16"	8-1/2"	9-11/16"	10-7/8"	12-1/16"	13-1/4"	14-7/16"	15-5/8"	16-13/16"	18"
Number of Bearing Bars	17	18	19	20	21	22	23	24	25	26	27	28	29	30	31
Panel Width	19-3/16"	20-3/8"	21-9/16"	22-3/4"	23-15/16"	25-1/8"	26-5/16"	27-1/2"	28-11/16"	29-7/8"	31-1/16"	32-1/4"	33-7/16"	34-5/8"	35-13/16"

Panel widths indicated are for gratings with 3/16" thick bearing bars. For 1/8" thick bearing bars deduct 1/16" from the stated values. Add 1/4" to all dimensions for extended cross bars on all aluminum products.

█ Indicates stock panel widths.

# Aluminum Bar Grating

Use this table when evaluating spans and loads for the following types of aluminum grating:

**15-SG-4, 15-SG-2, 15-SGI-4, 15-SGI-2, 15-SGF-4, 15-SGF-2, 15-ADT-4, & 15-ADT-2**

## 15 Space (15/16") Load Table

Bearing Bar Size (inches)	Approx. Weight psf *	Maximum Pedestrian Span**	Sec. Prop.*** Sx in <sup>2</sup> Ix in <sup>4</sup>	Unsupported Span												
				2'-0	2'-6	3'-0	3'-6	4'-0	4'-6	5'-0	5'-6	6'-0	6'-6	7'-0	8'-0	
3/4 x 3/16	2.4	3'-1"	0.225	U	450	288	200	147	113	All loads and deflections are theoretical and based upon the gross sections of the bearing bars, using a fiber stress of 12,000 psi.  The values are not intended to be absolute since the actual load capacity will be affected by the slight variations in mill and manufacturing tolerances.  Grating for spans to the left of the heavy line have a deflection ≤ 1/4" for uniform loads of 100 psf.  U = uniform load in pounds/sq. ft. C = concentrated load in pounds/foot of grating width D = deflection in inches						
				D	0.192	0.300	0.432	0.588	0.768							
				C	450	360	300	257	225							
3/4" I-Bar	2.0	3'-1"	0.084	D	0.154	0.240	0.346	0.470	0.614							
				U	533	341	237	174	133							105
				D	0.144	0.225	0.324	0.441	0.576							0.729
1 x 1/8	2.1	3'-6"	0.267	C	533	427	356	305	267							237
				D	0.115	0.180	0.259	0.353	0.461							0.583
				U	800	512	356	261	200							158
1 x 3/16	3.1	3'-10"	0.400	D	0.144	0.225	0.324	0.441	0.576							0.729
				C	800	640	533	457	400							356
				D	0.115	0.180	0.259	0.353	0.461							0.583
1" I-Bar	2.5	3'-10"	0.200	U	833	533	370	272	208	165	133					
				D	0.115	0.180	0.259	0.353	0.461	0.583	0.729					
				C	833	667	556	476	417	370	333					
1-1/4 x 1/8	2.6	4'-1"	0.417	D	0.092	0.144	0.207	0.282	0.369	0.467	0.576					
				U	1,250	800	556	408	313	247	200	165	139			
				D	0.115	0.180	0.259	0.353	0.461	0.583	0.729	0.871	1.037			
1-1/4 x 3/16	3.8	4'-7"	0.625	C	1,250	1,000	833	714	625	556	500	455	417			
				D	0.092	0.144	0.207	0.282	0.369	0.467	0.576	0.697	0.829			
				U	1,200	768	533	392	300	237	192	159	133	114	98	75
1-1/2 x 1/8	3.1	4'-8"	0.600	D	0.096	0.150	0.216	0.294	0.384	0.486	0.600	0.726	0.864	1.014	1.176	1.536
				C	1,200	960	800	686	600	533	480	436	400	369	343	300
				D	0.077	0.120	0.173	0.235	0.307	0.389	0.480	0.581	0.691	0.811	0.941	1.229
1-1/2 x 3/16	4.5	5'-3"	0.900	U	1,800	1,152	800	588	450	356	288	238	200	170	147	113
				D	0.096	0.150	0.216	0.294	0.384	0.486	0.600	0.726	0.864	1.014	1.176	1.536
				C	1,800	1,440	1,200	1,029	900	800	720	655	600	554	514	450
1-1/2" I-Bar	3.4	5'-3"	0.675	D	0.077	0.120	0.173	0.235	0.307	0.389	0.480	0.581	0.691	0.811	0.941	1.229
				U	1,633	1,045	726	533	408	323	261	216	182	155	133	102
				D	0.082	0.129	0.185	0.252	0.329	0.417	0.514	0.622	0.741	0.869	1.008	1.317
1-3/4 x 1/8	3.6	5'-4"	0.817	C	1,633	1,307	1,089	933	817	726	653	594	544	503	467	408
				D	0.066	0.103	0.148	0.202	0.263	0.333	0.411	0.498	0.592	0.695	0.806	1.053
				U	2,450	1,568	1,089	800	613	484	392	324	272	232	200	153
1-3/4 x 3/16	5.3	5'-10"	1.225	D	0.082	0.129	0.185	0.252	0.329	0.417	0.514	0.622	0.741	0.869	1.008	1.317
				C	2,450	1,960	1,633	1,400	1,225	1,089	980	891	817	754	700	613
				D	0.066	0.103	0.148	0.202	0.263	0.333	0.411	0.498	0.592	0.695	0.806	1.053
1-3/4" I-Bar	3.8	5'-10"	1.072	U	2,133	1,365	948	697	533	421	341	282	237	202	174	133
				D	0.072	0.113	0.162	0.221	0.288	0.365	0.450	0.545	0.648	0.761	0.882	1.152
				C	2,133	1,707	1,422	1,219	1,067	948	853	776	711	656	610	533
2 x 1/8	4.1	5'-10"	1.067	D	0.058	0.090	0.130	0.176	0.230	0.292	0.360	0.436	0.518	0.608	0.706	0.922
				U	3,200	2,048	1,422	1,045	800	632	512	423	356	303	261	200
				D	0.072	0.113	0.162	0.221	0.288	0.365	0.450	0.545	0.648	0.761	0.882	1.152
2" I-Bar	4.3	6'-6"	1.600	C	3,200	2,560	2,133	1,829	1,600	1,422	1,280	1,164	1,067	985	914	800
				D	0.058	0.090	0.130	0.176	0.230	0.292	0.360	0.436	0.518	0.608	0.706	0.922
				U	4,050	2,592	1,800	1,322	1,013	800	648	536	450	383	331	253
2-1/4 x 3/16	6.7	7'-1"	2.025	D	0.064	0.100	0.144	0.196	0.256	0.324	0.400	0.484	0.576	0.676	0.784	1.024
				C	4,050	3,240	2,700	2,314	2,025	1,800	1,620	1,473	1,350	1,246	1,157	1,013
				D	0.051	0.080	0.115	0.157	0.205	0.259	0.320	0.387	0.461	0.541	0.627	0.819
2-1/2 x 3/16	7.4	7'-8"	2.500	U	5,000	3,200	2,222	1,633	1,250	988	800	661	556	473	408	313
				D	0.058	0.090	0.130	0.176	0.230	0.292	0.360	0.436	0.518	0.608	0.706	0.922
				C	5,000	4,000	3,333	2,857	2,500	2,222	2,000	1,818	1,667	1,539	1,429	1,250
2-1/2" I-Bar	5.2	7'-8"	3.125	D	0.046	0.072	0.104	0.141	0.184	0.233	0.288	0.348	0.415	0.487	0.564	0.737

\* Weight per square foot based upon 15-SG-4 grating. Add .30 psf for 2" on center cross bars. \*\* Maximum pedestrian load is defined as a 100# uniform load with deflection ≤ 1/4 inch. (The 1/4" maximum deflection criteria is considered consistent with pedestrian comfort, but may be exceeded for other loading conditions at the discretion of the specifying authority.) \*\*\* Section properties per foot of width.

Note: When gratings with serrated surface are specified, the depth of the grating required for a specific load will be 1/4" greater than that shown in these tables.

### Panel Widths

Grating panels are available from stock in nominal 24" and 36" widths. When considering alternative widths, consult this table to select widths that will maintain uniform "out-to-out" spacing of the bearing bars. Specified widths deviating from this table will be fabricated to size with side banding and the bar spacing on one side of the finished panel will vary from the spacing throughout the remainder of the panel.

Number of Bearing Bars	2	3	4	5	6	7	8	9	10	11	12	13	14	15	16
Panel Width	1-1/8"	2-1/16"	3"	3-15/16"	4-7/8"	5-13/16"	6-3/4"	7-11/16"	8-5/8"	9-9/16"	10-1/2"	11-7/16"	12-3/8"	13-5/16"	14-1/4"
Number of Bearing Bars	17	18	19	20	21	22	23	24	25	26	27	28	29	30	31
Panel Width	15-3/16"	16-1/8"	17-1/16"	18"	18-15/16"	19-7/8"	20-13/16"	21-3/4"	22-11/16"	23-5/8"	24-9/16"	25-1/2"	26-7/16"	27-3/8"	28-5/16"
Number of Bearing Bars	32	33	34	35	36	37	38	39							
Panel Width	29-1/4"	30-3/16"	31-1/8"	32-1/16"	33"	33-15/16"	34-7/8"	35-13/16"							

Panel widths indicated are for gratings with 3/16" thick bearing bars. For 1/8" thick bearing bars deduct 1/16" from the stated values. Add 1/4" to all dimensions for extended cross bars on all aluminum products.

■ Indicates stock panel widths.

# Aluminum Bar Grating

## 11 Space (11/16") Load Table

Use this table when evaluating spans and loads for the following types of aluminum grating:  
**11-SG-4, 11-SG-2, 11-SGI-4, 11-SGI-2, 11-SGF-4, 11-SGF-2,**  
**11-ADT-4, & 11-ADT-2**

Bearing Bar Size (inches)	Approx. Weight psf *	Maximum Pedestrian Span**	Sec. Prop.*** Sx in <sup>3</sup> Ix in <sup>4</sup>	Unsupported Span														
				2'-0	2'-6	3'-0	3'-6	4'-0	4'-6	5'-0	5'-6	6'-0	6'-6	7'-0	8'-0			
3/4 x 3/16 3/4" I-Bar	3.2 2.7	3'-4"	0.307 0.115	U	614	393	273	200	153									
				D	0.192	0.300	0.432	0.588	0.768									
1 x 1/8 1" I-Bar	2.8 4.1	3'-9"	0.364 0.182	U	727	466	323	238	182	144								
				D	0.144	0.225	0.324	0.441	0.576	0.729								
1-1/4 x 1/8 1-1/4" I-Bar	3.5 5.1	4'-5"	0.568 0.355	U	1,136	727	505	371	284	225	182							
				D	0.115	0.180	0.259	0.353	0.461	0.583	0.720							
1-1/4 x 3/16 1-1/4" I-Bar	3.8	4'-11"	0.852 0.533	U	1,705	1,091	758	557	426	337	273	225	189					
				D	0.115	0.180	0.259	0.353	0.461	0.583	0.720	0.871	1.037					
1-1/2 x 1/8 1-1/2" I-Bar	4.1	5'-1"	0.818 0.614	U	1,636	1,047	727	534	409	323	262	216	182	155	134	102		
				D	0.096	0.150	0.216	0.294	0.384	0.486	0.600	0.726	0.864	1.014	1.176	1.336	1.536	
1-1/2 x 3/16 1-1/2" I-Bar	6.1	5'-8"	1.227 0.920	U	2,455	1,571	1,091	802	614	485	393	325	273	232	200	153		
				D	0.096	0.150	0.216	0.294	0.384	0.486	0.600	0.726	0.864	1.014	1.176	1.336	1.536	
1-3/4 x 1/8 1-3/4" I-Bar	4.8	5'-9"	1.144 0.974	U	2,227	1,426	990	727	557	440	356	295	248	211	182	139		
				D	0.082	0.129	0.185	0.252	0.329	0.417	0.514	0.622	0.741	0.869	1.008	1.162	1.317	
2 x 1/8 2" I-Bar	5.4	6'-4"	1.455 1.455	U	2,909	1,862	1,293	950	727	575	466	385	323	275	238	182		
				D	0.072	0.113	0.162	0.221	0.288	0.365	0.450	0.545	0.648	0.761	0.882	1.015	1.152	
2 x 3/16 2" I-Bar	8.0	7'-0"	2.182 2.182	U	4,364	2,793	1,939	1,425	1,091	862	698	577	485	413	356	273		
				D	0.072	0.113	0.162	0.221	0.288	0.365	0.450	0.545	0.648	0.761	0.882	1.015	1.152	
2-1/4 x 3/16 2-1/4" I-Bar	9.0	7'-8"	2.761 3.107	U	5,523	3,535	2,455	1,803	1,381	1,091	884	730	614	523	451	345		
				D	0.064	0.100	0.144	0.196	0.256	0.324	0.400	0.484	0.576	0.676	0.784	0.904	1.024	
2-1/2 x 3/16 2-1/2" I-Bar	10.0	8'-4"	3.409 4.261	U	6,818	4,364	3,030	2,226	1,705	1,347	1,091	902	758	646	557	426		
				D	0.058	0.090	0.130	0.176	0.230	0.292	0.360	0.436	0.518	0.608	0.706	0.812	0.922	

All loads and deflections are theoretical and based upon the gross sections of the bearing bars, using a fiber stress of 12,000 psi.

The values are not intended to be absolute since the actual load capacity will be affected by the slight variations in mill and manufacturing tolerances.

Grating for spans to the left of the heavy line have a deflection  $\leq 1/4"$  for uniform loads of 100 psf.

U = uniform load in pounds/sq. ft.  
 C = concentrated load in pounds/ft. of grating width  
 D = deflection in inches

\* Weight per square foot based upon 11-SG-4 grating. Add .30 psf for 2" on center cross bars. \*\* Maximum pedestrian load is defined as a 100# uniform load with deflection  $\leq 1/4$  inch. (The 1/4" maximum deflection criteria is considered consistent with pedestrian comfort, but may be exceeded for other loading conditions at the discretion of the specifying authority.) \*\*\* Section properties per foot of width.

**Note: When gratings with serrated surface are specified, the depth of the grating required for a specific load will be 1/4" greater than that shown in these tables.**

### Panel Widths

Grating panels are available from stock in nominal 24" and 36" widths. When considering alternative widths, consult this table to select widths that will maintain uniform "out-to-out" spacing of the bearing bars. Specified widths deviating from this table will be fabricated to size with side banding and the bar spacing on one side of the finished panel will vary from the spacing throughout the remainder of the panel.

Number of Bearing Bars	2	3	4	5	6	7	8	9	10	11	12	13	14	15	16
Panel Width	7/8"	1-9/16"	2-1/4"	2-15/16"	3-5/8"	4-5/16"	5"	5-11/16"	6-3/8"	7-1/16"	7-3/4"	8-7/16"	9-1/8"	9-13/16"	10-1/2"
Number of Bearing Bars	17	18	19	20	21	22	23	24	25	26	27	28	29	30	31
Panel Width	11-3/16"	11-7/8"	12-9/16"	13-1/4"	13-15/16"	14-5/8"	15-5/16"	16"	16-11/16"	17-3/8"	18-1/16"	18-3/4"	19-7/16"	20-1/8"	20-13/16"
Number of Bearing Bars	32	33	34	35	36	37	38	39	40	41	42	43	44	45	46
Panel Width	21-1/2"	22-3/16"	22-7/8"	23-9/16"	24-1/4"	24-15/16"	25-5/8"	26-5/16"	27"	27-11/16"	28-3/8"	29-1/16"	29-3/4"	30-7/16"	31-1/8"
Number of Bearing Bars	47	48	49	50	51	52	53								
Panel Width	31-13/16"	32-1/2"	33-3/16"	33-7/8"	34-9/16"	35-1/4"	35-15/16"								

Panel widths indicated are for gratings with 3/16" thick bearing bars. For 1/8" thick bearing bars deduct 1/16" from the stated values. Add 1/4" to all dimensions for extended cross bars on all aluminum products.

■ Indicates stock panel widths.

# Aluminum Bar Grating

Use this table when evaluating spans and loads for the following types of aluminum grating:

**8-SG-4, 8-SG-2, 8-SGI-4, 8-SGI-2, 8-SGF-4, 8-SGF-2, 8-ADT-4, & 8-ADT-2**

## 8 Space (1/2") Load Table

Bearing Bar Size (inches)	Approx. Weight psf *	Maximum Pedestrian Span**	Sec. Prop.*** Sx in <sup>2</sup> Ix in <sup>4</sup>	Unsupported Span												
				2'-0"	2'-6"	3'-0"	3'-6"	4'-0"	4'-6"	5'-0"	5'-6"	6'-0"	6'-6"	7'-0"	8'-0"	
3/4 x 3/16	4.3	3'-7"	0.422	U	844	540	375	276	211	167	All loads and deflections are theoretical and based upon the gross sections of the bearing bars, using a fiber stress of 12,000 psi.  The values are not intended to be absolute since the actual load capacity will be affected by the slight variations in mill and manufacturing tolerances.  Grating for spans to the left of the heavy line have a deflection ≤ 1/4" for uniform loads of 100 psf.  U = uniform load in pounds/sq. ft. C = concentrated load in pounds/ft. of grating width D = deflection in inches					
				D	0.192	0.300	0.432	0.588	0.768	0.972						
				C	844	675	563	482	422	375						
3/4" I-Bar	3.4	3'-7"	0.158	D	0.154	0.240	0.346	0.470	0.614	0.778						
				C	1,000	640	444	327	250	198						
				D	0.144	0.225	0.324	0.441	0.576	0.729						
1 x 1/8	3.8	4'-1"	0.500	C	1,000	800	667	571	500	444						
				D	0.115	0.180	0.259	0.353	0.461	0.583						
				C	1,500	1,200	1,000	857	750	667						
1 x 3/16	5.6	4'-6"	0.750	D	1,500	1,200	1,000	857	750	667						
				C	0.115	0.180	0.259	0.353	0.461	0.583						
				D	1,500	1,200	1,000	857	750	667						
1" I-Bar	4.3	4'-6"	0.375	D	1,500	1,200	1,000	857	750	667						
				C	0.115	0.180	0.259	0.353	0.461	0.583						
				D	1,500	1,200	1,000	857	750	667						
1-1/4 x 1/8	4.7	4'-10"	0.781	U	1,563	1,000	694	510	391	309						
				D	0.115	0.180	0.259	0.353	0.461	0.583						
				C	1,563	1,250	1,042	893	781	694						
1-1/4 x 3/16	7.0	5'-4"	1.172	D	0.092	0.144	0.207	0.282	0.369	0.467						
				C	2,344	1,500	1,042	765	586	463						
				D	0.115	0.180	0.259	0.353	0.461	0.583						
1-1/4" I-Bar	5.2	5'-4"	0.732	C	2,344	1,875	1,563	1,339	1,172	1,042						
				D	0.092	0.144	0.207	0.282	0.369	0.467						
				C	2,250	1,440	1,000	735	563	444						
1-1/2 x 1/8	5.6	5'-6"	1.125	D	0.096	0.150	0.216	0.294	0.384	0.486						
				C	2,250	1,800	1,500	1,286	1,125	1,000						
				D	0.077	0.120	0.173	0.235	0.307	0.389						
1-1/2 x 3/16	8.3	6'-1"	1.688	U	3,375	2,160	1,500	1,102	844	667						
				D	0.096	0.150	0.216	0.294	0.384	0.486						
				C	3,375	2,700	2,250	1,929	1,688	1,500						
1-1/2" I-Bar	6.0	6'-1"	1.266	D	0.077	0.120	0.173	0.235	0.307	0.389						
				C	3,063	1,960	1,361	1,000	766	605						
				D	0.082	0.129	0.185	0.252	0.329	0.417						
1-3/4 x 1/8	6.5	6'-2"	1.531	C	3,063	2,450	2,042	1,750	1,531	1,361						
				D	0.066	0.103	0.148	0.202	0.263	0.333						
				U	4,594	2,940	2,042	1,500	1,148	907						
1-3/4 x 3/16	9.6	6'-10"	2.297	D	0.082	0.129	0.185	0.252	0.329	0.417						
				C	4,594	3,675	3,063	2,625	2,297	2,042						
				D	0.066	0.103	0.148	0.202	0.263	0.333						
1-3/4" I-Bar	6.8	6'-10"	2.010	U	4,000	2,560	1,778	1,306	1,000	790						
				D	0.072	0.113	0.162	0.221	0.288	0.365						
				C	4,000	3,200	2,667	2,286	2,000	1,778						
2 x 1/8	7.4	6'-10"	2.000	D	0.058	0.090	0.130	0.176	0.230	0.292						
				C	6,000	3,840	2,667	1,959	1,500	1,185						
				D	0.072	0.113	0.162	0.221	0.288	0.365						
2 x 3/16	11.0	7'-7"	3.000	C	6,000	4,800	4,000	3,429	3,000	2,667						
				D	0.058	0.090	0.130	0.176	0.230	0.292						
				U	7,594	4,860	3,375	2,480	1,898	1,500						
2" I-Bar	7.7	7'-7"	3.000	D	0.064	0.100	0.144	0.196	0.256	0.324						
				C	7,594	6,075	5,063	4,339	3,797	3,375						
				D	0.051	0.080	0.115	0.157	0.205	0.259						
2-1/4 x 3/16	12.3	8'-4"	3.797	U	9,375	6,000	4,167	3,061	2,344	1,852						
				D	0.058	0.090	0.130	0.176	0.230	0.292						
				C	9,375	7,500	6,250	5,357	4,688	4,167						
2-1/4" I-Bar	8.5	8'-4"	4.271	D	0.046	0.072	0.104	0.141	0.184	0.233						
				C	9,375	7,500	6,250	5,357	4,688	4,167						
				D	0.046	0.072	0.104	0.141	0.184	0.233						
2-1/2 x 3/16	13.7	9'-0"	4.688	U	9,375	6,000	4,167	3,061	2,344	1,852						
				D	0.058	0.090	0.130	0.176	0.230	0.292						
				C	9,375	7,500	6,250	5,357	4,688	4,167						
2-1/2" I-Bar	9.5	9'-0"	5.859	D	0.046	0.072	0.104	0.141	0.184	0.233						
				C	9,375	7,500	6,250	5,357	4,688	4,167						
				D	0.046	0.072	0.104	0.141	0.184	0.233						

\* Weight per square foot based upon 8-SG-4 grating. Add .30 psf for 2" on center cross bars. \*\* Maximum pedestrian load is defined as a 100# uniform load with deflection ≤ 1/4 inch. (The 1/4" maximum deflection criteria is considered consistent with pedestrian comfort, but may be exceeded for other loading conditions at the discretion of the specifying authority.) \*\*\* Section properties per foot of width.

Note: When gratings with serrated surface are specified, the depth of the grating required for a specific load will be 1/4" greater than that shown in these tables.

### Panel Widths

Grating panels are available from stock in nominal 24" and 36" widths. When considering alternative widths, consult this table to select widths that will maintain uniform "out-to-out" spacing of the bearing bars. Specified widths deviating from this table will be fabricated to size with side banding and the bar spacing on one side of the finished panel will vary from the spacing throughout the remainder of the panel.

Number of Bearing Bars	2	3	4	5	6	7	8	9	10	11	12	13	14	15	16
Panel Width	11-1/16"	1-3/16"	1-11/16"	2-3/16"	2-11/16"	3-3/16"	3-11/16"	4-3/16"	4-11/16"	5-3/16"	5-11/16"	6-3/16"	6-11/16"	7-3/16"	7-11/16"
Number of Bearing Bars	17	18	19	20	21	22	23	24	25	26	27	28	29	30	31
Panel Width	8-3/16"	8-11/16"	9-3/16"	9-11/16"	10-3/16"	10-11/16"	11-3/16"	11-11/16"	12-3/16"	12-11/16"	13-3/16"	13-11/16"	14-3/16"	14-11/16"	15-3/16"
Number of Bearing Bars	32	33	34	35	36	37	38	39	40	41	42	43	44	45	46
Panel Width	15-11/16"	16-3/16"	16-11/16"	17-3/16"	17-11/16"	18-3/16"	18-11/16"	19-3/16"	19-11/16"	20-3/16"	20-11/16"	21-3/16"	21-11/16"	22-3/16"	22-11/16"
Number of Bearing Bars	47	48	49	50	51	52	53	54	55	56	57	58	59	60	61
Panel Width	23-3/16"	23-11/16"	24-3/16"	24-11/16"	25-3/16"	25-11/16"	26-3/16"	26-11/16"	27-3/16"	27-11/16"	28-3/16"	28-11/16"	29-3/16"	29-11/16"	30-3/16"
Number of Bearing Bars	62	63	64	65	66	67	68	69	70	71	72				
Panel Width	30-11/16"	31-3/16"	31-11/16"	32-3/16"	32-11/16"	33-3/16"	33-11/16"	34-3/16"	34-11/16"	35-3/16"	35-11/16"				

Panel widths indicated are for gratings with 3/16" thick bearing bars. For 1/8" thick bearing bars deduct 1/16" from the stated values. Add 1/4" to all dimensions for extended cross bars on all aluminum products.

■ Indicates stock panel widths.

# Aluminum Bar Grating

## 7 Space (7/16") Load Table

Use this table when evaluating spans and loads for the following types of aluminum grating:  
**7-SG-4, 7-SG-2, 7-SGI-4, 7-SGI-2, 7-SGF-4, 7-SGF-2, 7-ADT-4, & 7-ADT-2**

Bearing Bar Size (inches)	Approx. Weight psf *	Maximum Pedestrian Span**	Sec. Prop.*** Sx in <sup>3</sup> Ix in <sup>4</sup>	Unsupported Span																																
				2'-0	2'-6	3'-0	3'-6	4'-0	4'-6	5'-0	5'-6	6'-0	6'-6	7'-0	8'-0																					
3/4 x 3/16	4.8	3'-9"	0.482	U	964	617	429	315	241	191	All loads and deflections are theoretical and based upon the gross sections of the bearing bars, using a fiber stress of 12,000 psi.																									
				D	0.192	0.300	0.432	0.588	0.768	0.972																										
3/4" I-Bar	3.8	3'-9"	0.181	C	964	771	643	551	482	429																										
				D	0.154	0.240	0.346	0.470	0.614	0.778																										
1 x 1/8	4.3	4'-2"	0.571	U	1,143	731	508	373	286	226							183	The values are not intended to be absolute since the actual load capacity will be affected by the slight variations in mill and manufacturing tolerances.																		
				D	0.144	0.225	0.324	0.441	0.576	0.729							0.900																			
1 x 3/16	6.3	4'-8"	0.857	C	1,143	914	762	653	571	508							457							Grating for spans to the left of the heavy line have a deflection ≤ 1/4" for uniform loads of 100 psf.												
				D	0.115	0.180	0.259	0.353	0.461	0.583							0.720																			
1" I-Bar	4.8	4'-8"	0.429	U	1,714	1,097	762	560	429	339							274													227	183	143	103	63	23	8
				D	0.144	0.225	0.324	0.441	0.576	0.729							0.900													1.089	1.286	1.491	1.704	1.926	2.157	2.395
1-1/4 x 1/8	5.3	4'-11"	0.893	C	1,714	1,371	1,143	980	857	762							686													623	567	516	468	423	380	339
				D	0.115	0.180	0.259	0.353	0.461	0.583							0.720													0.871	1.030	1.197	1.371	1.550	1.734	1.923
1-1/4 x 3/16	7.9	5'-6"	1.339	U	1,786	1,143	794	583	446	353	286	236	183	131	80	29	10													4						
				D	0.115	0.180	0.259	0.353	0.461	0.583	0.720	0.871	1.030	1.197	1.371	1.550	1.734													1.923	2.117					
1-1/4" I-Bar	5.8	5'-6"	0.837	C	1,786	1,429	1,191	1,020	893	794	714	649	587	536	487	441	396													353						
				D	0.092	0.144	0.207	0.282	0.369	0.467	0.576	0.697	0.829	0.973	1.122	1.277	1.438													1.604	1.775					
1-1/2 x 1/8	6.3	5'-8"	1.286	U	2,571	1,646	1,143	840	643	508	411	340	286	243	210	161	112	67																		
				D	0.096	0.150	0.216	0.294	0.384	0.486	0.600	0.726	0.864	1.014	1.176	1.336	1.503	1.676	1.854																	
1-1/2 x 3/16	9.4	6'-4"	1.929	C	2,571	2,057	1,714	1,469	1,286	1,143	1,029	935	857	791	735	643	567	491																		
				D	0.077	0.120	0.173	0.235	0.307	0.389	0.480	0.581	0.691	0.811	0.941	1.077	1.219	1.367	1.520																	
1-1/2" I-Bar	6.8	6'-4"	1.446	U	3,857	2,469	1,714	1,260	964	762	617	510	429	365	315	241	161	81																		
				D	0.096	0.150	0.216	0.294	0.384	0.486	0.600	0.726	0.864	1.014	1.176	1.336	1.503	1.676																		
1-3/4 x 1/8	7.4	6'-5"	1.750	C	3,857	3,086	2,571	2,204	1,929	1,714	1,543	1,403	1,286	1,187	1,102	964	824																			
				D	0.077	0.120	0.173	0.235	0.307	0.389	0.480	0.581	0.691	0.811	0.941	1.077	1.219																			
1-3/4 x 3/16	10.9	7'-1"	2.625	U	3,500	2,240	1,556	1,143	875	691	560	463	389	331	286	219	143																			
				D	0.082	0.129	0.185	0.252	0.329	0.417	0.514	0.622	0.741	0.869	1.008	1.137	1.275																			
1-3/4" I-Bar	7.7	7'-1"	2.297	C	3,500	2,800	2,333	2,000	1,750	1,556	1,400	1,273	1,167	1,077	1,000	875																				
				D	0.066	0.103	0.148	0.202	0.263	0.333	0.411	0.498	0.592	0.691	0.806	0.926																				
2 x 1/8	8.4	7'-1"	2.286	U	5,250	3,360	2,333	1,714	1,313	1,037	840	694	583	497	429	328																				
				D	0.082	0.129	0.185	0.252	0.329	0.417	0.514	0.622	0.741	0.869	1.008	1.137																				
2 x 3/16	12.5	7'-10"	3.429	C	5,250	4,200	3,500	3,000	2,625	2,333	2,100	1,909	1,750	1,615	1,500	1,313																				
				D	0.066	0.103	0.148	0.202	0.263	0.333	0.411	0.498	0.592	0.691	0.806	0.926																				
2" I-Bar	8.7	7'-10"	3.429	U	4,571	2,926	2,032	1,493	1,143	903	731	605	508	433	373	286																				
				D	0.072	0.113	0.162	0.221	0.288	0.365	0.450	0.545	0.648	0.761	0.882	1.012																				
2-1/4 x 3/16	14.0	8'-7"	4.339	C	4,571	3,657	3,048	2,612	2,286	2,032	1,829	1,662	1,524	1,407	1,306	1,143																				
				D	0.058	0.090	0.130	0.176	0.230	0.292	0.360	0.436	0.518	0.608	0.706	0.812																				
2-1/4" I-Bar	9.6	8'-7"	4.882	U	6,857	4,389	3,048	2,239	1,714	1,355	1,097	907	762	649	560	429																				
				D	0.072	0.113	0.162	0.221	0.288	0.365	0.450	0.545	0.648	0.761	0.882	1.012																				
2-1/2 x 3/16	15.5	9'-3"	5.357	C	6,857	5,486	4,571	3,918	3,429	3,048	2,743	2,494	2,286	2,110	1,959	1,714																				
				D	0.058	0.090	0.130	0.176	0.230	0.292	0.360	0.436	0.518	0.608	0.706	0.812																				
2-1/2" I-Bar	10.7	9'-3"	6.696	U	8,679	5,554	3,857	2,834	2,170	1,714	1,389	1,148	964	822	709	542																				
				D	0.064	0.100	0.144	0.196	0.256	0.324	0.400	0.484	0.576	0.676	0.784	0.904																				
2-1/2" I-Bar	10.7	9'-3"	6.696	C	8,679	6,943	5,786	4,959	4,339	3,857	3,471	3,156	2,893	2,670	2,480	2,170																				
				D	0.051	0.080	0.115	0.157	0.205	0.259	0.320	0.387	0.461	0.541	0.627	0.719																				
2-1/2" I-Bar	10.7	9'-3"	6.696	U	10,714	6,857	4,762	3,499	2,679	2,116	1,714	1,417	1,191	1,014	875	670																				
				D	0.058	0.090	0.130	0.176	0.230	0.292	0.360	0.436	0.518	0.608	0.706	0.812																				
2-1/2" I-Bar	10.7	9'-3"	6.696	C	10,714	8,571	7,143	6,122	5,357	4,762	4,286	3,896	3,571	3,297	3,061	2,679																				
				D	0.046	0.072	0.104	0.141	0.184	0.233	0.288	0.348	0.415	0.487	0.564	0.637																				

\* Weight per square foot based upon 7-SG-4 grating. Add .30 psf for 2" on center cross bars. \*\* Maximum pedestrian load is defined as a 100# uniform load with deflection ≤ 1/4 inch. (The 1/4" maximum deflection criteria is considered consistent with pedestrian comfort, but may be exceeded for other loading conditions at the discretion of the specifying authority.) \*\*\* Section properties per foot of width.

Note: When gratings with serrated surface are specified, the depth of the grating required for a specific load will be 1/4" greater than that shown in these tables.

### Panel Widths

Grating panels are available from stock in nominal 24" and 36" widths. When considering alternative widths, consult this table to select widths that will maintain uniform "out-to-out" spacing of the bearing bars. Specified widths deviating from this table will be fabricated to size with side banding and the bar spacing on one side of the finished panel will vary from the spacing throughout the remainder of the panel.

Number of Bearing Bars	2	3	4	5	6	7	8	9	10	11	12	13	14	15	16
Panel Width	5/8"	1-1/16"	1-1/2"	1-15/16"	2-3/8"	2-13/16"	3-1/4"	3-11/16"	4-1/8"	4-9/16"	5"	5-7/16"	5-7/8"	6-5/16"	6-3/4"
Number of Bearing Bars	17	18	19	20	21	22	23	24	25	26	27	28	29	30	31
Panel Width	7-3/16"	7-5/8"	8-1/16"	8-1/2"	8-15/16"	9-3/8"	9-13/16"	10-1/4"	10-11/16"	11-1/8"	11-9/16"	12"	12-7/16"	12-7/8"	13-5/16"
Number of Bearing Bars	32	33	34	35	36	37	38	39	40	41	42	43	44	45	46
Panel Width	13-3/4"	14-3/16"	14-5/8"	15-1/16"	15-1/2"	15-15/16"	16-3/8"	16-13/16"	17-1/4"	17-11/16"	18-1/8"	18-9/16"	19"	19-7/16"	19-7/8"
Number of Bearing Bars	47	48	49	50	51	52	53	54	55	56	57	58	59	60	61
Panel Width	20-5/16"	20-3/4"	21-3/16"	21-5/8"	22-1/16"	22-1/2"	22-15/16"	23-3/8"	23-13/16"	24-1/4"	24-11/16"	25-1/8"	25-9/16"	26"	26-7/16"
Number of Bearing Bars	62	63	64	65	66	67	68	69	70	71	72	73	74	75	76
Panel Width	26-7/8"	27-5/16"	27-3/4"	28-3/16"	28-5/8"	29-1/16"	29-1/2"	29-15/16"	30-3/8"	30-13/16"	31-1/4"	31-11/16"	32-1/8"	32-9/16"	33"
Number of Bearing Bars	77	78	79	80	81	82	83								
Panel Width	33-7/16"	33-7/8"	34-5/16"	34-3/4"	35-3/16"	35-5/8"	36-1/16"								

Panel widths indicated are for gratings with 3/16" thick bearing bars. For 1/8" thick bearing bars deduct 1/16" from the stated values. Add 1/4" to all dimensions for extended cross bars on all aluminum products.

■ Indicates stock panel widths.

## Aluminum Stair Treads

Aluminum stair treads are available fabricated to any size in types "SG" and "SGI" swage locked, type "ADT" aluminum dovetail pressure locked, or type "SGF" aluminum flush-top grating. Treads are manufactured with a defined visible nosing and pre-punched end carrier plates or angles, ready for bolting or welding to the stair stringers.

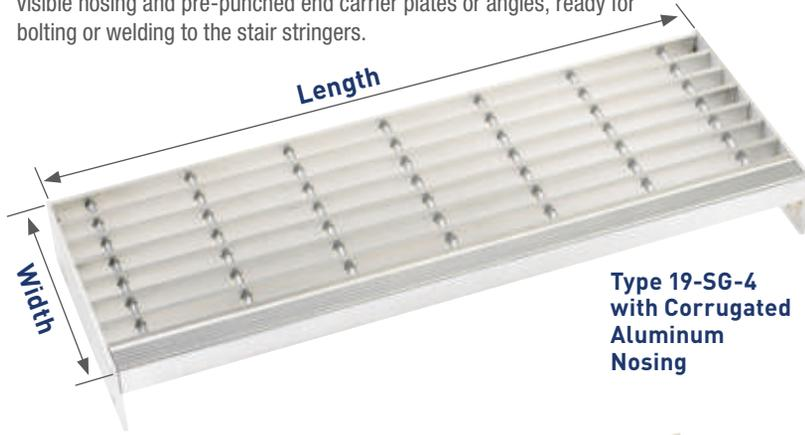

**Type 19-SG-4  
with Corrugated  
Aluminum  
Nosing**



**Type 7-SG-4  
with Cast  
Abrasive  
Nosing**

## Aluminum Carrier Plates & Angles

### Aluminum Carrier Plates

Recommended for use with 19, 15, and 11 spaced gratings

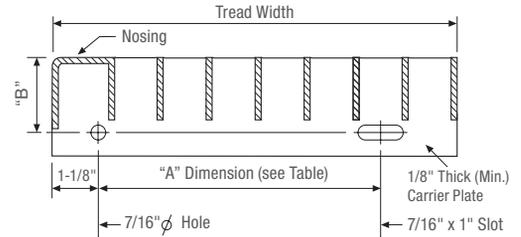

"B" Dimension  
2-1/4" for 1" thru 1-3/4" bearing bars  
3-1/4" for 2" thru 2-1/2" bearing bars

### Aluminum Carrier Angles

Recommended for use with 8 and 7 spaced gratings

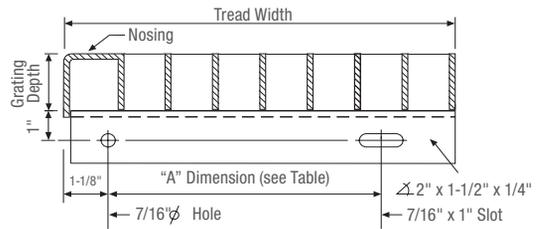

### Nosing Options



Corrugated aluminum nosing welded to grating and carrier plates/angles.

Cast abrasive nosing mechanically fastened to welded mounting angle.

## Table of Stair Tread Widths

19 Space			15 Space			11 Space			8 Space			7 Space		
Bearing Bars @ 1-3/16" O.C.			Bearing Bars @ 15/16" O.C.			Bearing Bars @ 11/16" O.C.			Bearing Bars @ 1/2" O.C.			Bearing Bars @ 7/16" O.C.		
Nominal Tread Width	Number of Bearing Bars	Standard "A" Dimension	Nominal Tread Width	Number of Bearing Bars	Standard "A" Dimension	Nominal Tread Width	Number of Bearing Bars	Standard "A" Dimension	Nominal Tread Width	Number of Bearing Bars	Standard "A" Dimension	Nominal Tread Width	Number of Bearing Bars	Standard "A" Dimension
6-1/4"	5	2-1/2"	7"	7	4-1/2"	6-1/4"	8	2-1/2"	6-1/2"	11	2-1/2"	6-3/4"	13	2-1/2"
7-3/8"	6	4-1/2"	8"	8	4-1/2"	7-5/8"	10	4-1/2"	7-1/2"	13	4-1/2"	7-5/8"	15	4-1/2"
8-1/2"	7	4-1/2"	8-7/8"	9	4-1/2"	9"	12	4-1/2"	9"	16	4-1/2"	8-1/2"	17	4-1/2"
9-3/4"	8	7"	9-7/8"	10	7"	10-3/8"	14	7"	10"	18	7"	10-1/8"	21	7"
11"	9	7"	10-3/4"	11	7"	11"	15	7"	11"	20	7"	11-1/8"	23	7"
12-1/8"	10	7"	11-5/8"	12	7"	11-3/4"	16	7"	12"	22	7"	12"	25	7"

## Recommended Maximum Aluminum Stair Tread Lengths\*

Bearing Bar Size	19 Space		15 Space		11 Space		8 Space		7 Space	
	1-3/16" O.C.		15/16" O.C.		11/16" O.C.		1/2" O.C.		7/16" O.C.	
	Plain	Serrated	Plain	Serrated	Plain	Serrated	Plain	Serrated	Plain	Serrated
1" x 3/16" or 1" I-Bar	2'-4"	2'-2"	2'-6"	2'-3"	2'-8"	2'-4"	3'-0"	2'-8"	3'-2"	2'-9"
1-1/4" x 3/16" or 1-1/4" I-Bar	2'-10"	2'-7"	3'-1"	2'-9"	3'-4"	3'-0"	3'-11"	3'-5"	4'-1"	3'-7"
1-1/2" x 3/16" or 1-1/2" I-Bar	3'-6"	3'-2"	3'-10"	3'-5"	4'-2"	3'-9"	4'-11"	4'-5"	5'-2"	4'-7"
1-3/4" x 3/16" or 1-3/4" I-Bar	4'-3"	3'-10"	4'-8"	4'-3"	5'-1"	4'-7"	5'-6"	5'-6"	5'-6"	5'-6"
2" x 3/16" or 2" I-Bar	5'-1"	4'-8"	5'-6"	5'-1"	5'-6"	5'-6"	5'-6"	5'-6"	5'-6"	5'-6"
2-1/4" x 3/16" or 2-1/4" I-Bar	5'-6"	5'-6"	5'-6"	5'-6"	5'-6"	5'-6"	5'-10"	5'-6"	6'-1"	5'-9"
2-1/2" x 3/16" or 2-1/2" I-Bar	5'-6"	5'-6"	5'-7"	5'-6"	5'-11"	5'-7"	6'-5"	6'-2"	6'-8"	6'-4"

\* For treads up to 5'-6", maximum tread lengths are based upon 300 lb. concentrated load on the front 5 inches of the tread, at the center of the tread length. When treads exceed 5'-6" in length, design allows for 300 lb. concentrated loads at 1/3 points of tread length. Deflection is limited to the lesser of .250" or 1/240 of tread length in all cases.

# Aluminum Plank



**Aluminum Plank Grating** is a structurally sound and cosmetically attractive alternative to bar grating. Extruded in 6" and 2-1/2" wide sections, plank grating is relatively maintenance-free and has no parts to work loose or splinter.

The solid, striated walking surface can be provided "unpunched," which restricts the passage of debris and is preferred for odor containment applications. When the passage of air, light, heat, or moisture is desired, aluminum plank can be punched with a variety of hole patterns including rectangular, square, round, or diagonal. Enhanced slip-resistance is available by specifying "upset" punched square or rectangular patterns.

**Heavy Duty Rectangular Punched**



**Solid "Unpunched" Aluminum Plank**

## Plank Options

### Heavy Duty – Plain Sides

Heavy duty aluminum plank is available with plain sides in depths ranging from 3/4" to 2-1/2".

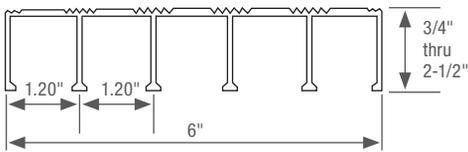

### Heavy Duty – Interlocking

Male-female interlocking heavy duty plank is available in 6" or 2-1/2" widths, 1" deep.

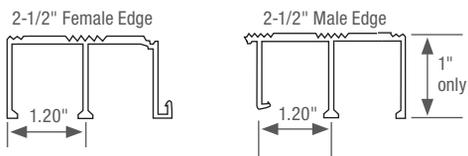
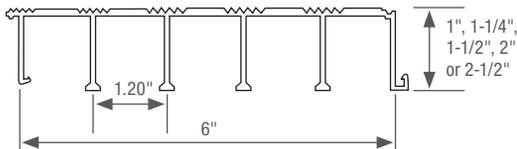

### Light Series – Plain Sides

Available in 6" wide, plain side planks only.

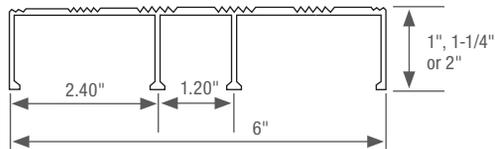

## Punch Patterns

### Unpunched

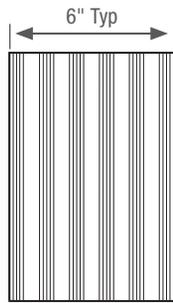

### Square & Round Punched

#### Square Upset Pattern

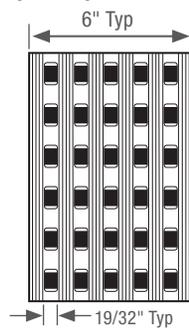

#### Round In-Line Pattern

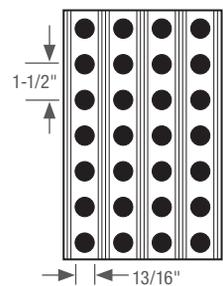

### Rectangular Punched

#### Upset Pattern GP

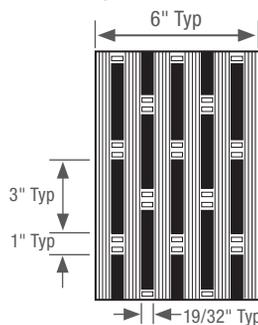

#### Upset Pattern WACO

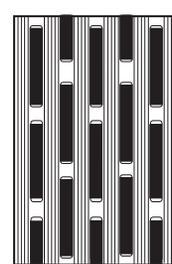

#### Plain Pattern

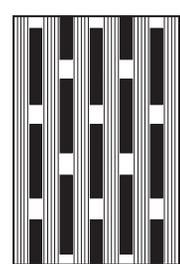

### Diagonal Punched

#### ALPlank 8\*

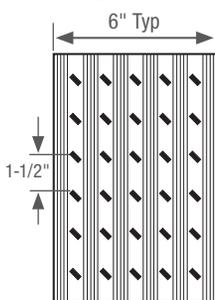

#### ALPlank 15\*

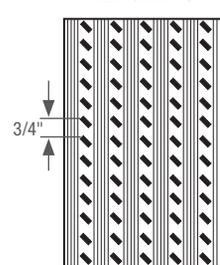

#### ALPlank 22\*

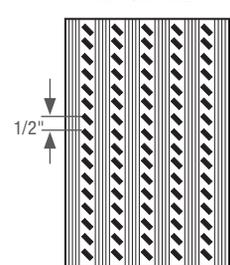

\* indicates % open area

**Aluminum Plank Grating** is available in 20' or 26' stock lengths or fabricated to specified size by Grating Pacific. Individual 6" wide planks can be banded together to form standard panel widths for ease of handling and installation.

## Load Tables

When the width of the total area does not result in an overall measurement divisible by six inch sections, the last piece in the run can be shop modified to facilitate a proper fit.

### Heavy Duty Aluminum Plank Load Table

Plank Depth	Ped. Span (inches)	Sect. Prop.* Sx, in <sup>2</sup> Ix, in <sup>4</sup>	Weight per Sq. Ft.			Clear Span																		
			Non Punched	Rect. Punched	Square Punched	2'-0"	2'-6"	3'-0"	3'-6"	4'-0"	4'-6"	5'-0"	5'-6"	6'-0"	6'-6"	7'-0"	8'-0"							
3/4"	39	0.217 0.103	2.2	1.8	2.0	U	435	278	193	142	108	85	69	Loads and deflections given in this table are theoretical, and are based on a unit stress of 12,000 psi  U = safe uniform load in pounds/sq. ft. C = safe concentrated load in pounds/ft. of grating width D = deflection in inches										
						D	0.121	0.237	0.342	0.465	0.608	0.770	0.950											
						C	435	348	290	248	217	193	174											
1"	49	0.416 0.241	2.6	2.2	2.4	U	833	533	370	272	208	164	133							110	92	75	62	
						D	0.124	0.193	0.279	0.380	0.496	0.628	0.775							0.938	1.117			
						C	833	666	555	476	416	370	333							302	277			
1-1/4"	58	0.732 0.491	3.2	2.8	3.0	U	1,464	936	650	478	366	289	234							193	162	138	119	91
						D	0.107	0.167	0.241	0.328	0.428	0.542	0.669							0.810	0.964	1.131	1.312	1.714
						C	1,464	1,171	976	836	732	650	585							532	488	450	418	366
1-1/2"	67	1.083 0.861	3.8	3.4	3.6	U	2,167	1,387	963	707	541	428	346							286	240	205	176	135
						D	0.090	0.141	0.203	0.277	0.362	0.458	0.566							0.684	0.815	0.956	1.109	1.449
						C	2,167	1,734	1,445	1,238	1,083	963	867							788	722	666	619	541
1-3/4"	75	1.496 1.367	4.4	4.0	4.2	U	2,992	1,915	1,330	977	748	591	478	395	332	283	244	187						
						D	0.078	0.123	0.177	0.241	0.315	0.398	0.492	0.595	0.708	0.832	0.964	1.260						
						C	2,992	2,394	1,995	1,710	1,496	1,330	1,197	1,088	997	920	855	748						
2"	83	1.987 2.063	4.9	4.5	4.7	U	3,975	2,544	1,766	1,298	993	785	636	525	441	376	324	248						
						D	0.069	0.108	0.156	0.212	0.277	0.351	0.433	0.524	0.624	0.732	0.849	1.109						
						C	3,975	3,180	2,650	2,271	1,987	1,766	1,590	1,445	1,325	1,223	1,135	993						
2-1/4"	91	2.554 3.004	5.5	5.0	5.3	U	5,109	3,270	2,270	1,668	1,277	1,009	817	675	567	483	417	319						
						D	0.061	0.095	0.137	0.187	0.244	0.309	0.382	0.462	0.550	0.646	0.749	0.979						
						C	5,109	4,087	3,406	2,919	2,554	2,270	2,043	1,858	1,703	1,572	1,459	1,277						
2-1/2"	97	2.985 3.887	5.9	5.5	5.7	U	5,971	3,821	2,654	1,949	1,492	1,179	955	789	663	565	487	373						
						D	0.055	0.086	0.124	0.169	0.221	0.279	0.345	0.418	0.497	0.584	0.677	0.884						
						C	5,971	4,777	3,981	3,412	2,985	2,654	2,388	2,171	1,990	1,837	1,706	1,492						
						D	0.044	0.069	0.099	0.135	0.176	0.223	0.276	0.334	0.398	0.467	0.541	0.707						

Note: Grating for spans to the left of the heavy line have a deflection of less than 1/4" for uniform loads of 100 lbs./sq. ft. This is the maximum deflection to afford pedestrian comfort and can be exceeded for other types of load at the discretion of the specifying authority. The actual Ped (pedestrian) Span under this condition is shown above for each size grating. This grating conforms to MIL-G-18015 (SHIPS).

### Light Series Load Table

Plank Depth	Sect. Prop.* Sx, in <sup>2</sup> Ix, in <sup>4</sup>	Weight Per Sq. Ft.			Clear Span						
		Un-Punched	Rect. Punched	Square Punched	2'-0"	2'-6"	3'-0"	3'-6"	4'-0"	4'-6"	
1"	0.273	2.1	1.7	1.9	U	546	349	242	178	136	107
					D	0.113	0.177	0.254	0.347	0.452	0.570
	0.173				C	546	436	364	312	273	242
					D	0.090	0.141	0.204	0.278	0.363	0.458

#### Panel Width Chart

Plank Depth	Panel Width	Panel Width	Panel Width	Panel Width
6"	1-1/2"	2-11/16"	3-7/8"	5-1/8"
12"	7-1/2"	8-11/16"	9-7/8"	11-1/8"
18"	13-1/2"	14-11/16"	15-7/8"	17-1/8"
24"	19-1/2"	20-11/16"	21-7/8"	23-1/8"
30"	25-1/2"	26-11/16"	27-7/8"	29-1/8"
36"	31-1/2"	32-11/16"	33-7/8"	35-1/8"
	37-1/2"	38-11/16"	39-7/8"	41-1/8"

#### % Open Area\*

Rectangular	37%
Square	23%

\* Based on punched plank



# Stainless Steel Bar Grating

**Stainless Steel Bar Grating** is manufactured from alloy types 304, 304L, 316, or 316L and available in grating types “WS” (welded stainless), “DTS” (dovetail stainless pressure locked), and “SLS” (swage locked stainless). Popular for highly corrosive environments and long-lasting architectural applications, stainless steel bar gratings are available with bearing bar spacing ranging from 19/16" (1-3/16") to 7/16" on center and with cross bars at 4" or 2" on center. Each product is available with standard plain or optional serrated or Algrip surfaces. Finish options are diverse and should be carefully considered.

## Type “WS” Welded Stainless Steel Grating

Our strongest and most economical stainless product, type “WS” gratings are manufactured by forge welding rectangular bearing bars and drawn cross bars. This welding process provides a positive fused intersection providing years of service under the most demanding conditions.

Type “WS” stainless gratings are available in “19 space” (1-3/16"), “15 space” (15/16") and “11 space” (11/16") bearing bar centers. Standard cross bar spacing is 4" on center and the optional 2" cross bar spacing is also available.



Type  
19-WS-4



## Type “DTS” Dovetail Pressure Locked Stainless

Manufactured with a deep rectangular cross bar, type “DTS” dovetail stainless grating is commonly preferred for architectural applications. Sunscreens, grilles and infill panels are just some of the applications where this distinct “egg-crate” configuration is the ideal accent.

Type “DTS” stainless gratings are available with bearing bar spacings ranging from 19/16" (1-3/16") to 7/16" on center.

For applications where increased bearing bar spacing is desired, consider the architectural products presented on page 57 of this catalog.

## Type “SLS” Swage Locked Stainless

Hollow tube cross bars are hydraulically swaged into pre-punched holes in the bearing bars to make type “SLS” swage locked stainless grating. This type of construction provides a secure bearing bar/cross bar intersection and products are available with bearing bar spacings ranging from 19/16" (1-3/16") to 7/16" on center.

This attractive grating, with the swaged cross bars slightly below the top surface of the grating, is very popular for “close-mesh”, ADA conforming applications. Consider “11 space” or “7 space” gratings for vault covers or entrance mats located in the public way.



## Stainless Steel Finishes

As produced, stainless steel products typically display discoloration caused by the introduction of heat during welding, cutting, or grinding processes. If appearance is important to your application, consideration should be given to secondary cleaning or electro-polishing.



**Mill Finish** – Products will display discoloration from welding, cutting, and grinding. Satisfactory for industrial or process applications where appearance is not a consideration.



**Commercial Clean** – A uniform, matte finish is achieved by abrasive blasting followed by passivation to remove manufacturing contaminants.



**Electro-Polished** – A bright, chrome-like appearance achieved by immersion in chemicals that clean and “polish” the base metal.

## Stainless Steel Grating Table of Spacings

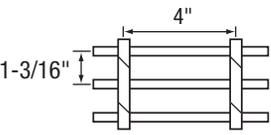
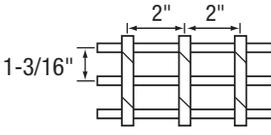
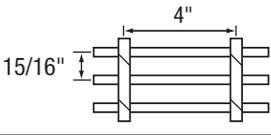
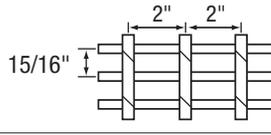
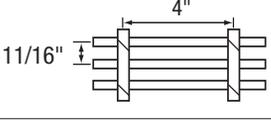
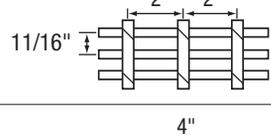
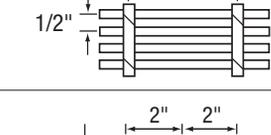
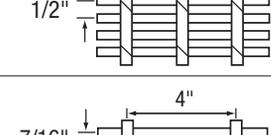
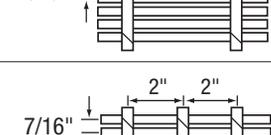
Part No.	Spacing	Open Area*	
19-WS-4 19-DTS-4 19-SLS-4		78%	Bearing bars spaced at 1-3/16" on center and cross bars at 4" on center. The workhorse of industrial flooring, popular for platforms, catwalks, mezzanines and stairways.
19-WS-2 19-DTS-2 19-SLS-2		73%	Bearing bars spaced at 1-3/16" on center and cross bars at 2" on center. Excellent for short spans and applications where small wheeled carts continuously cross the grating surface.
15-WS-4 15-DTS-4 15-SLS-4		75%	Bearing bars spaced at 15/16" on center and cross bars at 4" on center. The closer spaced bearing bars increase load capacity by more than 26% when compared to similar gratings produced with bearing bars a 1-3/16" on center.
15-WS-2 15-DTS-2 15-SLS-2		69%	Bearing bars spaced at 15/16" on center and close spaced cross bars at 2" on center. The closer spaced bearing bars and cross bars provide additional flooring surface to support pedestrian and wheeled traffic.
11-WS-4 11-DTS-4 11-SLS-4		68%	Bearing bars spaced at 11/16" on center and cross bars at either 4" or 2" on center. Types 11-4 and 11-2 with 3/16" thick bearing bars comply with the spacing requirements of the Americans with Disabilities Act. For ADA installations, specify that the bearing bars span perpendicular to the normal flow of traffic.
11-WS-2 11-DTS-2 11-SLS-2		63%	
8-DTS-4 8-SLS-4		58%	Bearing bars spaced at 1/2" on center and cross bars at 4" or 2" on center. Types 8-4 and 8-2 comply with ADA spacing requirements. These products are popular for material handling platforms and mezzanines subject to continuous cart and dolly traffic.
8-DTS-2 8-SLS-2		54%	
7-DTS-4 7-SLS-4		53%	Bearing bars spaced at 7/16" on center and cross bars at 4" or 2" on center. Types 7-4 and 7-2 comply with ADA spacing requirements and are popular for applications in the public way. When specified with 3/16" thick bearing bars, 7-4 and 7-2 gratings have a net 1/4" clear opening between the bearing bars and commonly reject intrusion by high heeled shoes.
7-DTS-2 7-SLS-2		49%	

\* Percentage of open area is based upon 3/16" thick bearing bars and .275" cross bars. Contact Grating Pacific if exact open area calculation is required for alternative bearing bar thicknesses or cross bar sizes.

### How to Specify Stainless Steel Bar Grating

- Select type of grating
  - "WS" for welded stainless steel grating
  - "DTS" for dovetail pressure locked stainless steel grating
  - "SLS" for swage locked stainless steel grating
- Select bar spacing from table above
- Select bearing bar size (consult load tables on pages 24-28 considering service loads and clear spans)
- Specify plain, serrated, or Algrip surface
- Specify banding or additional trim required
- Specify finish
  - Mill finish
  - Abrasive blast
  - Commercial clean
  - Electro-polished
- Specify fasteners (if required) – see page 59

# Stainless Steel Bar Grating

## 19 Space

### (1-3/16") Load Table

Use this table when evaluating spans and loads for the following types of stainless steel grating: **19-WS-4, 19-WS-2, 19-DTS-4, 19-DTS-2, 19-SLS-4, & 19-SLS-2**

Bearing Bar Size (inches)	Approx. Weight psf*	Max. Ped. Span**	Sec. Prop.*** Sx in <sup>3</sup> Ix in <sup>4</sup>	Unsupported Span																							
				2'-0"	2'-6"	3'-0"	3'-6"	4'-0"	4'-6"	5'-0"	5'-6"	6'-0"	6'-6"	7'-0"	8'-0"	9'-0"											
3/4 x 1/8	3.9	3'-5"	0.118 0.044	U	395	253	175	129	99	78	All loads and deflections are theoretical and based upon the gross sections of the bearing bars, using a fiber stress of 20,000 psi.  The values are not intended to be absolute since the actual load capacity will be affected by the slight variations in mill and manufacturing tolerances.  Grating for spans to the left of the heavy line have a deflection ≤ 1/4" for uniform loads of 100 psf.  U = uniform load in pounds/sq. ft. C = concentrated load in pounds/ft. of grating width D = deflection in inches																
				D	0.114	0.179	0.257	0.350	0.457	0.579																	
				C	395	316	263	226	197	175																	
3/4 x 3/16	5.6	3'-9"	0.178 0.067	U	592	379	263	193	148	117	95																
				D	0.114	0.179	0.257	0.350	0.457	0.579	0.714																
				C	592	474	395	338	296	263	237																
1 x 1/8	5.0	4'-3"	0.211 0.105	U	702	449	312	229	175	139	112	93															
				D	0.086	0.134	0.193	0.263	0.343	0.434	0.536	0.648															
				C	702	561	468	401	351	312	281	255															
1 x 3/16	7.2	4'-8"	0.316 0.158	U	1,053	674	468	344	263	208	168	139	117														
				D	0.086	0.134	0.193	0.263	0.343	0.434	0.536	0.648	0.771														
				C	1,053	842	702	602	526	468	421	383	351														
1-1/4 x 1/8	6.1	5'-0"	0.329 0.206	U	1,097	702	487	358	274	217	175	145	122	104													
				D	0.069	0.107	0.154	0.210	0.274	0.347	0.429	0.519	0.617	0.724													
				C	1,097	877	731	627	548	487	439	399	366	337													
1-1/4 x 3/16	8.9	5'-6"	0.493 0.308	U	1,645	1,053	731	537	411	325	263	218	183	156	134												
				D	0.069	0.107	0.154	0.210	0.274	0.347	0.429	0.519	0.617	0.724	0.840												
				C	1,645	1,316	1,097	940	822	731	658	598	548	506	470												
1-1/2 x 1/8	7.2	5'-9"	0.474 0.355	U	1,579	1,011	702	516	395	312	253	209	175	150	129												
				D	0.057	0.089	0.129	0.175	0.229	0.289	0.357	0.432	0.514	0.604	0.700												
				C	1,579	1,263	1,053	902	790	702	632	574	526	486	451												
1-1/2 x 3/16	10.7	6'-4"	0.711 0.533	U	2,368	1,516	1,053	773	592	468	379	313	263	224	193	148											
				D	0.057	0.089	0.129	0.175	0.229	0.289	0.357	0.432	0.514	0.604	0.700	0.914											
				C	2,368	1,895	1,579	1,353	1,184	1,053	947	861	790	729	677	592											
1-3/4 x 1/8	8.5	6'-5"	0.645 0.564	U	2,149	1,375	955	702	537	425	344	284	239	204	175	134	106										
				D	0.049	0.077	0.110	0.150	0.196	0.248	0.306	0.370	0.441	0.517	0.600	0.784	0.992										
				C	2,149	1,719	1,433	1,228	1,075	955	860	782	716	661	614	537	478										
1-3/4 x 3/16	12.3	7'-2"	0.967 0.846	U	3,224	2,063	1,433	1,053	806	637	516	426	358	305	263	202	159										
				D	0.049	0.077	0.110	0.150	0.196	0.248	0.306	0.370	0.441	0.517	0.600	0.784	0.992										
				C	3,224	2,579	2,149	1,842	1,612	1,433	1,290	1,172	1,075	992	921	806	716										
2 x 1/8	9.6	7'-1"	0.842 0.842	U	2,807	1,797	1,248	917	702	555	449	371	312	266	229	175	139										
				D	0.043	0.067	0.096	0.131	0.171	0.217	0.268	0.324	0.386	0.453	0.525	0.686	0.868										
				C	2,807	2,246	1,871	1,604	1,404	1,248	1,123	1,021	936	864	802	702	624										
2 x 3/16	13.9	7'-11"	1.263 1.263	U	4,211	2,695	1,871	1,375	1,053	832	674	557	468	399	344	263	208										
				D	0.043	0.067	0.096	0.131	0.171	0.217	0.268	0.324	0.386	0.453	0.525	0.686	0.868										
				C	4,211	3,368	2,807	2,406	2,105	1,871	1,684	1,531	1,404	1,296	1,203	1,053	936										
2-1/4 x 3/16	15.6	8'-8"	1.599 1.799	U	5,329	3,411	2,368	1,740	1,332	1,053	853	705	592	505	435	333	263										
				D	0.038	0.060	0.086	0.117	0.152	0.193	0.238	0.288	0.343	0.402	0.467	0.610	0.771										
				C	5,329	4,263	3,553	3,045	2,665	2,368	2,132	1,938	1,776	1,640	1,523	1,332	1,184										
2-1/2 x 3/16	17.2	9'-4"	1.974 2.467	U	6,579	4,211	2,924	2,148	1,645	1,300	1,053	870	731	623	537	411	325										
				D	0.034	0.054	0.077	0.105	0.137	0.174	0.214	0.259	0.309	0.362	0.420	0.549	0.694										
				C	6,579	5,263	4,386	3,759	3,290	2,924	2,632	2,392	2,193	2,024	1,880	1,645	1,462										
				D	0.027	0.043	0.062	0.084	0.110	0.139	0.171	0.207	0.247	0.290	0.336	0.439	0.555										

\* Weight per square foot based upon 19-WS-4 grating. Add .60 psf for 2" on center cross bars. \*\* Maximum pedestrian load is defined as a 100# uniform load with deflection ≤ 1/4 inch. (The 1/4" maximum deflection criteria is considered consistent with pedestrian comfort, but may be exceeded for other loading conditions at the discretion of the specifying authority.) \*\*\* Section properties per foot of width.

Note: When gratings with serrated surface are specified, the depth of the grating required for a specific load will be 1/4" greater than that shown in these tables.

### Panel Widths

Grating panels are available from stock in nominal 24" and 36" widths. When considering alternative widths, consult this table to select widths that will maintain uniform "out-to-out" spacing of the bearing bars. Specified widths deviating from this table will be fabricated to size with side banding and the bar spacing on one side of the finished panel will vary from the spacing throughout the remainder of the panel.

Number of Bearing Bars	2	3	4	5	6	7	8	9	10	11	12	13	14	15	16
Panel Width	1-3/8"	2-9/16"	3-3/4"	4-15/16"	6-1/8"	7-5/16"	8-1/2"	9-11/16"	10-7/8"	12-1/16"	13-1/4"	14-7/16"	15-5/8"	16-13/16"	18"
Number of Bearing Bars	17	18	19	20	21	22	23	24	25	26	27	28	29	30	31
Panel Width	19-3/16"	20-3/8"	21-9/16"	22-3/4"	23-15/16"	25-1/8"	26-5/16"	27-1/2"	28-11/16"	29-7/8"	31-1/16"	32-1/4"	33-7/16"	34-5/8"	35-13/16"

Panel widths indicated are for gratings with 3/16" thick bearing bars. For 1/8" thick bearing bars deduct 1/16" from the stated values.

■ Indicates stock panel widths.

# Stainless Steel Bar Grating

## 15 Space

Use this table when evaluating spans and loads for the following types of stainless steel grating:

### 15-WS-4, 15-WS-2, 15-DTS-4, 15-DTS-2, 15-SLS-4, & 15-SLS-2 (15/16") Load Table

Bearing Bar Size (inches)	Approx. Weight psf *	Max. Ped. Span**	Sec. Prop.*** Sx in <sup>3</sup> Ix in <sup>4</sup>	Unsupported Span													
				2'-0"	2'-6"	3'-0"	3'-6"	4'-0"	4'-6"	5'-0"	5'-6"	6'-0"	6'-6"	7'-0"	8'-0"	9'-0"	
3/4 x 3/16	6.9	4'-0"	0.225 0.084	U	750	480	333	245	188	148	120	All loads and deflections are theoretical and based upon the gross sections of the bearing bars, using a fiber stress of 20,000 psi.  The values are not intended to be absolute since the actual load capacity will be affected by the slight variations in mill and manufacturing tolerances.  Grating for spans to the left of the heavy line have a deflection ≤ 1/4" for uniform loads of 100 psf.  U = uniform load in pounds/sq. ft. C = concentrated load in pounds/ft. of grating width D = deflection in inches					
				D	0.114	0.179	0.257	0.350	0.457	0.579	0.714						
				C	750	600	500	429	375	333	300						
				D	0.091	0.143	0.206	0.280	0.366	0.463	0.571						
1 x 1/8	6.2	4'-6"	0.267 0.133	U	889	569	395	290	222	176	142						
				D	0.086	0.134	0.193	0.263	0.343	0.434	0.536						
				C	889	711	593	508	444	395	356						
				D	0.069	0.107	0.154	0.210	0.274	0.347	0.429						
1 x 3/16	8.9	4'-11"	0.400 0.200	U	1,333	853	593	435	333	263	213	176	148				
				D	0.086	0.134	0.193	0.263	0.343	0.434	0.536	0.648	0.771				
				C	1,333	1,067	889	762	667	593	533	485	444				
				D	0.069	0.107	0.154	0.210	0.274	0.347	0.429	0.519	0.617				
1-1/4 x 1/8	7.5	5'-4"	0.417 0.260	U	1,389	889	617	454	347	274	222	184	154	132			
				D	0.069	0.107	0.154	0.210	0.274	0.347	0.429	0.519	0.617	0.724			
				C	1,389	1,111	926	794	694	617	556	505	463	427			
				D	0.055	0.086	0.123	0.168	0.219	0.278	0.343	0.415	0.494	0.579			
1-1/4 x 3/16	11.0	5'-10"	0.625 0.391	U	2,083	1,333	926	680	521	412	333	276	232	197	170		
				D	0.069	0.107	0.154	0.210	0.274	0.347	0.429	0.519	0.617	0.724	0.840		
				C	2,083	1,667	1,389	1,191	1,042	926	833	758	694	641	595		
				D	0.055	0.086	0.123	0.168	0.219	0.278	0.343	0.415	0.494	0.579	0.672		
1-1/2 x 1/8	8.9	6'-1"	0.600 0.450	U	2,000	1,280	889	653	500	395	320	265	222	189	163	125	
				D	0.057	0.089	0.129	0.175	0.229	0.289	0.357	0.432	0.514	0.604	0.700	0.914	
				C	2,000	1,600	1,333	1,143	1,000	889	800	727	667	615	571	500	
				D	0.046	0.071	0.103	0.140	0.183	0.231	0.286	0.346	0.411	0.483	0.560	0.731	
1-1/2 x 3/16	13.2	6'-9"	0.900 0.675	U	3,000	1,920	1,333	980	750	593	480	397	333	284	245	188	148
				D	0.057	0.089	0.129	0.175	0.229	0.289	0.357	0.432	0.514	0.604	0.700	0.914	1.157
				C	3,000	2,400	2,000	1,714	1,500	1,333	1,200	1,091	1,000	923	857	750	667
				D	0.046	0.071	0.103	0.140	0.183	0.231	0.286	0.346	0.411	0.483	0.560	0.731	0.926
1-3/4 x 1/8	10.4	6'-10"	0.817 0.715	U	2,722	1,742	1,210	889	681	538	436	360	303	258	222	170	134
				D	0.049	0.077	0.110	0.150	0.196	0.248	0.306	0.370	0.441	0.517	0.600	0.784	0.992
				C	2,722	2,178	1,815	1,556	1,361	1,210	1,089	990	907	838	778	681	605
				D	0.039	0.061	0.088	0.120	0.157	0.198	0.245	0.296	0.353	0.414	0.480	0.627	0.793
1-3/4 x 3/16	15.3	7'-7"	1.225 1.072	U	4,083	2,613	1,815	1,333	1,021	807	653	540	454	387	333	255	202
				D	0.049	0.077	0.110	0.150	0.196	0.248	0.306	0.370	0.441	0.517	0.600	0.784	0.992
				C	4,083	3,267	2,722	2,333	2,042	1,815	1,633	1,485	1,361	1,256	1,167	1,021	907
				D	0.039	0.061	0.088	0.120	0.157	0.198	0.245	0.296	0.353	0.414	0.480	0.627	0.793
2 x 1/8	11.8	7'-7"	1.067 1.067	U	3,556	2,276	1,580	1,161	889	702	569	470	395	337	290	222	176
				D	0.043	0.067	0.096	0.131	0.171	0.217	0.268	0.324	0.386	0.453	0.525	0.686	0.868
				C	3,556	2,844	2,370	2,032	1,778	1,580	1,422	1,293	1,185	1,094	1,016	889	790
				D	0.034	0.054	0.077	0.105	0.137	0.174	0.214	0.259	0.309	0.362	0.420	0.549	0.694
2 x 3/16	17.3	8'-4"	1.600 1.600	U	5,333	3,413	2,370	1,742	1,333	1,054	853	705	593	505	435	333	263
				D	0.043	0.067	0.096	0.131	0.171	0.217	0.268	0.324	0.386	0.453	0.525	0.686	0.868
				C	5,333	4,267	3,556	3,048	2,667	2,370	2,133	1,939	1,778	1,641	1,524	1,333	1,185
				D	0.034	0.054	0.077	0.105	0.137	0.174	0.214	0.259	0.309	0.362	0.420	0.549	0.694
2-1/4 x 3/16	19.4	9'-2"	2.025 2.278	U	6,750	4,320	3,000	2,204	1,688	1,333	1,080	893	750	639	551	422	333
				D	0.038	0.060	0.086	0.117	0.152	0.193	0.238	0.288	0.343	0.402	0.467	0.610	0.771
				C	6,750	5,400	4,500	3,857	3,375	3,000	2,700	2,455	2,250	2,077	1,929	1,688	1,500
				D	0.030	0.048	0.069	0.093	0.122	0.154	0.190	0.230	0.274	0.322	0.373	0.488	0.617
2-1/2 x 3/16	21.5	9'-11"	2.500 3.125	U	8,333	5,333	3,704	2,721	2,083	1,646	1,333	1,102	926	789	680	521	412
				D	0.034	0.054	0.077	0.105	0.137	0.174	0.214	0.259	0.309	0.362	0.420	0.549	0.694
				C	8,333	6,667	5,556	4,762	4,167	3,704	3,333	3,030	2,778	2,564	2,381	2,083	1,852
				D	0.027	0.043	0.062	0.084	0.110	0.139	0.171	0.207	0.247	0.290	0.336	0.439	0.555

\* Weight per square foot based upon 15-WS-4 grating. Add .60 psf for 2" on center cross bars. \*\* Maximum pedestrian load is defined as a 100# uniform load with deflection ≤ 1/4 inch. (The 1/4" maximum deflection criteria is considered consistent with pedestrian comfort, but may be exceeded for other loading conditions at the discretion of the specifying authority.) \*\*\* Section properties per foot of width.

Note: When gratings with serrated surface are specified, the depth of the grating required for a specific load will be 1/4" greater than that shown in these tables.

### Panel Widths

Grating panels are available from stock in nominal 24" and 36" widths. When considering alternative widths, consult this table to select widths that will maintain uniform "out-to-out" spacing of the bearing bars. Specified widths deviating from this table will be fabricated to size with side banding and the bar spacing on one side of the finished panel will vary from the spacing throughout the remainder of the panel.

Number of Bearing Bars	2	3	4	5	6	7	8	9	10	11	12	13	14	15	16
Panel Width	1-1/8"	2-1/16"	3"	3-15/16"	4-7/8"	5-13/16"	6-3/4"	7-11/16"	8-5/8"	9-9/16"	10-1/2"	11-7/16"	12-3/8"	13-5/16"	14-1/4"
Number of Bearing Bars	17	18	19	20	21	22	23	24	25	26	27	28	29	30	31
Panel Width	15-3/16"	16-1/8"	17-1/16"	18"	18-15/16"	19-7/8"	20-13/16"	21-3/4"	22-11/16"	23-5/8"	24-9/16"	25-1/2"	26-7/16"	27-3/8"	28-5/16"
Number of Bearing Bars	32	33	34	35	36	37	38	39							
Panel Width	29-1/4"	30-3/16"	31-1/8"	32-1/16"	33"	33-15/16"	34-7/8"	35-13/16"							

Panel widths indicated are for gratings with 3/16" thick bearing bars. For 1/8" thick bearing bars deduct 1/16" from the stated values.

■ Indicates stock panel widths.



# Stainless Steel Bar Grating

## 8 Space (1/2") Load Table

Use this table when evaluating spans and loads for the following types of stainless steel grating:  
**8-DTS-4, 8-DTS-2, 8-SLS-4, & 8-SLS-2**

Bearing Bar Size (inches)	Approx. Weight psf *	Max. Ped. Span**	Sec. Prop.*** Sx in <sup>3</sup> Ix in <sup>4</sup>	Unsupported Span																	
				2'-0	2'-6	3'-0	3'-6	4'-0	4'-6	5'-0	5'-6	6'-0	6'-6	7'-0	8'-0	9'-0					
3/4 x 3/16	12.3	4'-8"	0.422 0.158	U	1,406	900	625	459	352	278	225	All loads and deflections are theoretical and based upon the gross sections of the bearing bars, using a fiber stress of 20,000 psi.  The values are not intended to be absolute since the actual load capacity will be affected by the slight variations in mill and manufacturing tolerances.  Grating for spans to the left of the heavy line have a deflection ≤ 1/4" for uniform loads of 100 psf.  U = uniform load in pounds/sq. ft. C = concentrated load in pounds/ft. of grating width D = deflection in inches									
				D	0.114	0.179	0.257	0.350	0.457	0.579	0.714										
				C	1,406	1,125	938	804	703	625	563										
				D	0.091	0.143	0.206	0.280	0.366	0.463	0.571										
1 x 1/8	11.0	5'-3"	0.500 0.250	U	1,667	1,067	741	544	417	329	267						220	189	161	139	121
				D	0.086	0.134	0.193	0.263	0.343	0.434	0.536						0.648	0.771	0.909	1.059	
				C	1,667	1,333	1,111	952	833	741	667						606	553	506	464	
				D	0.069	0.107	0.154	0.210	0.274	0.347	0.429						0.519	0.617	0.724	0.840	0.977
1 x 3/16	16.2	5'-10"	0.750 0.375	U	2,500	1,600	1,111	816	625	494	400						331	278	234	197	
				D	0.086	0.134	0.193	0.263	0.343	0.434	0.536						0.648	0.771	0.909	1.059	
				C	2,500	2,000	1,667	1,429	1,250	1,111	1,000						909	833	767	706	649
				D	0.069	0.107	0.154	0.210	0.274	0.347	0.429						0.519	0.617	0.724	0.840	0.977
1-1/4 x 1/8	13.6	6'-2"	0.781 0.488	U	2,604	1,667	1,157	850	651	514	417	344	289	247	211						
				D	0.069	0.107	0.154	0.210	0.274	0.347	0.429	0.519	0.617	0.724	0.840	0.977					
				C	2,604	2,083	1,736	1,488	1,302	1,157	1,042	947	868	801	741	686					
				D	0.055	0.086	0.123	0.168	0.219	0.278	0.343	0.415	0.494	0.579	0.672	0.778					
1-1/4 x 3/16	20.0	6'-10"	1.172 0.732	U	3,906	2,500	1,736	1,276	977	772	625	517	434	370	319	244					
				D	0.069	0.107	0.154	0.210	0.274	0.347	0.429	0.519	0.617	0.724	0.840	1.097					
				C	3,906	3,125	2,604	2,232	1,953	1,736	1,563	1,421	1,302	1,202	1,116	1,042	977				
				D	0.055	0.086	0.123	0.168	0.219	0.278	0.343	0.415	0.494	0.579	0.672	0.778					
1-1/2 x 1/8	16.2	7'-1"	1.125 0.844	U	3,750	2,400	1,667	1,225	938	741	600	496	417	355	306	234					
				D	0.057	0.089	0.129	0.175	0.229	0.289	0.357	0.432	0.514	0.604	0.700	0.914					
				C	3,750	3,000	2,500	2,143	1,875	1,667	1,500	1,364	1,250	1,154	1,071	938					
				D	0.046	0.071	0.103	0.140	0.183	0.231	0.286	0.346	0.411	0.483	0.560	0.731					
1-1/2 x 3/16	24.0	7'-11"	1.688 1.266	U	5,625	3,600	2,500	1,837	1,406	1,111	900	744	625	533	459	352	278				
				D	0.057	0.089	0.129	0.175	0.229	0.289	0.357	0.432	0.514	0.604	0.700	0.914	1.157				
				C	5,625	4,500	3,750	3,214	2,813	2,500	2,250	2,046	1,875	1,731	1,607	1,406	1,250				
				D	0.046	0.071	0.103	0.140	0.183	0.231	0.286	0.346	0.411	0.483	0.560	0.731	0.926				
1-3/4 x 1/8	18.9	8'-0"	1.531 1.340	U	5,104	3,267	2,269	1,667	1,276	1,008	817	675	567	483	417	319	252				
				D	0.049	0.077	0.110	0.150	0.196	0.248	0.306	0.370	0.441	0.517	0.600	0.784	0.992				
				C	5,104	4,083	3,403	2,917	2,552	2,269	2,042	1,856	1,701	1,571	1,458	1,276	1,134				
				D	0.039	0.061	0.088	0.120	0.157	0.198	0.245	0.296	0.353	0.414	0.480	0.627	0.793				
1-3/4 x 3/16	27.9	8'-10"	2.297 2.010	U	7,656	4,900	3,403	2,500	1,914	1,512	1,225	1,012	851	725	625	479	378				
				D	0.049	0.077	0.110	0.150	0.196	0.248	0.306	0.370	0.441	0.517	0.600	0.784	0.992				
				C	7,656	6,125	5,104	4,375	3,828	3,403	3,063	2,784	2,552	2,356	2,188	1,914	1,701				
				D	0.039	0.061	0.088	0.120	0.157	0.198	0.245	0.296	0.353	0.414	0.480	0.627	0.793				
2 x 1/8	21.5	8'-10"	2.000 2.000	U	6,667	4,267	2,963	2,177	1,667	1,317	1,067	882	741	631	544	417	329				
				D	0.043	0.067	0.096	0.131	0.171	0.217	0.268	0.324	0.386	0.453	0.525	0.686	0.868				
				C	6,667	5,333	4,444	3,810	3,333	2,963	2,667	2,424	2,222	2,051	1,905	1,667	1,482				
				D	0.034	0.054	0.077	0.105	0.137	0.174	0.214	0.259	0.309	0.362	0.420	0.549	0.694				
2 x 3/16	31.8	9'-9"	3.000 3.000	U	10,000	6,400	4,444	3,265	2,500	1,975	1,600	1,322	1,111	947	816	625	494				
				D	0.043	0.067	0.096	0.131	0.171	0.217	0.268	0.324	0.386	0.453	0.525	0.686	0.868				
				C	10,000	8,000	6,667	5,714	5,000	4,444	4,000	3,636	3,333	3,077	2,857	2,500	2,222				
				D	0.034	0.054	0.077	0.105	0.137	0.174	0.214	0.259	0.309	0.362	0.420	0.549	0.694				
2-1/4 x 3/16	35.7	10'-8"	3.797 4.271	U	12,656	8,100	5,625	4,133	3,164	2,500	2,025	1,674	1,406	1,198	1,033	791	625				
				D	0.038	0.060	0.086	0.117	0.152	0.193	0.238	0.288	0.343	0.402	0.467	0.610	0.771				
				C	12,656	10,125	8,438	7,232	6,328	5,625	5,063	4,602	4,219	3,894	3,616	3,164	2,813				
				D	0.030	0.048	0.069	0.093	0.122	0.154	0.190	0.230	0.274	0.322	0.373	0.488	0.617				
2-1/2 x 3/16	39.6	11'-7"	4.688 5.859	U	15,625	10,000	6,944	5,102	3,906	3,086	2,500	2,066	1,736	1,479	1,276	977	772				
				D	0.034	0.054	0.077	0.105	0.137	0.174	0.214	0.259	0.309	0.362	0.420	0.549	0.694				
				C	15,625	12,500	10,417	8,929	7,813	6,944	6,250	5,682	5,208	4,808	4,464	3,906	3,472				
				D	0.027	0.043	0.062	0.084	0.110	0.139	0.171	0.207	0.247	0.290	0.336	0.439	0.555				

\* Weight per square foot based upon 8-SLS-4 grating. Add .30 psf for 2" on center cross bars. \*\* Maximum pedestrian load is defined as a 100# uniform load with deflection ≤ 1/4 inch. (The 1/4" maximum deflection criteria is considered consistent with pedestrian comfort, but may be exceeded for other loading conditions at the discretion of the specifying authority.) \*\*\* Section properties per foot of width.

**Note: When gratings with serrated surface are specified, the depth of the grating required for a specific load will be 1/4" greater than that shown in these tables.**

### Panel Widths

Grating panels are available from stock in nominal 24" and 36" widths. When considering alternative widths, consult this table to select widths that will maintain uniform "out-to-out" spacing of the bearing bars. Specified widths deviating from this table will be fabricated to size with side banding and the bar spacing on one side of the finished panel will vary from the spacing throughout the remainder of the panel.

Number of Bearing Bars	2	3	4	5	6	7	8	9	10	11	12	13	14	15	16
Panel Width	11-1/16"	1-3/16"	1-11/16"	2-3/16"	2-11/16"	3-3/16"	3-11/16"	4-3/16"	4-11/16"	5-3/16"	5-11/16"	6-3/16"	6-11/16"	7-3/16"	7-11/16"
Number of Bearing Bars	17	18	19	20	21	22	23	24	25	26	27	28	29	30	31
Panel Width	8-3/16"	8-11/16"	9-3/16"	9-11/16"	10-3/16"	10-11/16"	11-3/16"	11-11/16"	12-3/16"	12-11/16"	13-3/16"	13-11/16"	14-3/16"	14-11/16"	15-3/16"
Number of Bearing Bars	32	33	34	35	36	37	38	39	40	41	42	43	44	45	46
Panel Width	15-11/16"	16-3/16"	16-11/16"	17-3/16"	17-11/16"	18-3/16"	18-11/16"	19-3/16"	19-11/16"	20-3/16"	20-11/16"	21-3/16"	21-11/16"	22-3/16"	22-11/16"
Number of Bearing Bars	47	48	49	50	51	52	53	54	55	56	57	58	59	60	61
Panel Width	23-3/16"	23-11/16"	24-3/16"	24-11/16"	25-3/16"	25-11/16"	26-3/16"	26-11/16"	27-3/16"	27-11/16"	28-3/16"	28-11/16"	29-3/16"	29-11/16"	30-3/16"
Number of Bearing Bars	62	63	64	65	66	67	68	69	70	71	72				
Panel Width	30-11/16"	31-3/16"	31-11/16"	32-3/16"	32-11/16"	33-3/16"	33-11/16"	34-3/16"	34-11/16"	35-3/16"	35-11/16"				

Panel widths indicated are for gratings with 3/16" thick bearing bars. For 1/8" thick bearing bars deduct 1/16" from the stated values.

■ Indicates stock panel widths.

# Stainless Steel Bar Grating

## 7 Space (7/16") Load Table

Use this table when evaluating spans and loads for the following types of stainless steel grating:  
**7-DTS-4, 7-DTS-2, 7-SLS-4, & 7-SLS-2**

Bearing Bar Size (inches)	Approx. Weight psf *	Max. Ped. Span**	Sec. Prop.*** Sx in <sup>3</sup> Ix in <sup>4</sup>	Unsupported Span																			
				2'-0	2'-6	3'-0	3'-6	4'-0	4'-6	5'-0	5'-6	6'-0	6'-6	7'-0	8'-0	9'-0							
3/4 x 3/16	13.9	4'-10"	0.482 0.181	U	1,607	1,029	714	525	402	318	257	All loads and deflections are theoretical and based upon the gross sections of the bearing bars, using a fiber stress of 20,000 psi.  The values are not intended to be absolute since the actual load capacity will be affected by the slight variations in mill and manufacturing tolerances.  Grating for spans to the left of the heavy line have a deflection ≤ 1/4" for uniform loads of 100 psf.	0.714	U = uniform load in pounds/sq. ft. C = concentrated load in pounds/ft. of grating width D = deflection in inches	0.905	279	212						
				D	0.114	0.179	0.257	0.350	0.457	0.579	0.714		0.840		1.097			1.157					
				C	1,607	1,286	1,071	918	804	714	643		587		531			487	452	417	382	347	
				D	0.091	0.143	0.206	0.280	0.366	0.463	0.571		0.693		0.829			0.974	1.129	1.294	1.469	1.644	
1 x 1/8	12.4	5'-5"	0.571 0.286	U	1,905	1,219	847	622	476	376	305		252		200			150	100	50	0		
				D	0.086	0.134	0.193	0.263	0.343	0.434	0.536		0.648		0.762			0.874	0.986	1.098	1.210	1.322	
				C	1,905	1,524	1,270	1,088	952	847	762		693		633			573	513	453	393	333	
				D	0.069	0.107	0.154	0.210	0.274	0.347	0.429		0.519		0.617			0.724	0.831	0.938	1.045	1.152	
1 x 3/16	18.3	6'-0"	0.857 0.429	U	2,857	1,829	1,270	933	714	564	457		378		318			271	224	177	130		
				D	0.086	0.134	0.193	0.263	0.343	0.434	0.536		0.648		0.771			0.905	1.039	1.173	1.307	1.441	
				C	2,857	2,286	1,905	1,633	1,429	1,270	1,143		1,039		952			879	806	733	660	587	514
				D	0.069	0.107	0.154	0.210	0.274	0.347	0.429		0.519		0.617			0.724	0.831	0.938	1.045	1.152	1.259
1-1/4 x 1/8	15.3	6'-5"	0.893 0.558	U	2,976	1,905	1,323	972	744	588	476		394		331			282	233	184	135		
				D	0.069	0.107	0.154	0.210	0.274	0.347	0.429	0.519	0.617	0.724	0.831	0.938	1.045	1.152					
				C	2,976	2,381	1,984	1,701	1,488	1,323	1,191	1,082	992	916	840	764	688	612	536				
				D	0.055	0.086	0.123	0.168	0.219	0.278	0.343	0.415	0.494	0.579	0.664	0.749	0.834	0.919	1.004				
1-1/4 x 3/16	22.7	7'-1"	1.339 0.837	U	4,464	2,857	1,984	1,458	1,116	882	714	590	496	423	364	305	246						
				D	0.069	0.107	0.154	0.210	0.274	0.347	0.429	0.519	0.617	0.724	0.831	0.938	1.045	1.152					
				C	4,464	3,571	2,976	2,551	2,232	1,984	1,786	1,623	1,488	1,374	1,276	1,188	1,100	1,012	924				
				D	0.055	0.086	0.123	0.168	0.219	0.278	0.343	0.415	0.494	0.579	0.664	0.749	0.834	0.919	1.004				
1-1/2 x 1/8	18.3	7'-4"	1.286 0.964	U	4,286	2,743	1,905	1,399	1,071	847	686	567	476	406	350	294	238						
				D	0.057	0.089	0.129	0.175	0.229	0.289	0.357	0.432	0.514	0.604	0.700	0.804	0.914	1.024					
				C	4,286	3,429	2,857	2,449	2,143	1,905	1,714	1,558	1,429	1,319	1,225	1,131	1,037	943	849				
				D	0.046	0.071	0.103	0.140	0.183	0.231	0.286	0.346	0.411	0.483	0.560	0.637	0.714	0.791	0.868				
1-1/2 x 3/16	27.2	8'-2"	1.929 1.446	U	6,429	4,114	2,857	2,099	1,607	1,270	1,029	850	714	609	525	441	357						
				D	0.057	0.089	0.129	0.175	0.229	0.289	0.357	0.432	0.514	0.604	0.700	0.804	0.914	1.024					
				C	6,429	5,143	4,286	3,674	3,214	2,857	2,571	2,338	2,143	1,978	1,837	1,707	1,587	1,467	1,347				
				D	0.046	0.071	0.103	0.140	0.183	0.231	0.286	0.346	0.411	0.483	0.560	0.637	0.714	0.791	0.868				
1-3/4 x 1/8	21.3	8'-3"	1.750 1.531	U	5,833	3,733	2,593	1,905	1,458	1,152	933	771	648	552	476	406	336						
				D	0.049	0.077	0.110	0.150	0.196	0.248	0.306	0.370	0.441	0.517	0.600	0.688	0.784	0.880					
				C	5,833	4,667	3,889	3,333	2,917	2,593	2,333	2,121	1,944	1,795	1,667	1,548	1,429	1,310	1,191				
				D	0.039	0.061	0.088	0.120	0.157	0.198	0.245	0.296	0.353	0.414	0.480	0.547	0.614	0.681	0.748				
1-3/4 x 3/16	31.6	9'-2"	2.625 2.297	U	8,750	5,600	3,889	2,857	2,188	1,728	1,400	1,157	972	828	714	624	534						
				D	0.049	0.077	0.110	0.150	0.196	0.248	0.306	0.370	0.441	0.517	0.600	0.688	0.784	0.880					
				C	8,750	7,000	5,833	5,000	4,375	3,889	3,500	3,182	2,917	2,692	2,500	2,188	1,944	1,700	1,456				
				D	0.039	0.061	0.088	0.120	0.157	0.198	0.245	0.296	0.353	0.414	0.480	0.547	0.614	0.681	0.748				
2 x 1/8	24.3	9'-2"	2.286 2.286	U	7,619	4,876	3,386	2,488	1,905	1,505	1,219	1,008	847	721	622	536	450						
				D	0.043	0.067	0.096	0.131	0.171	0.217	0.268	0.324	0.386	0.453	0.525	0.600	0.686	0.772					
				C	7,619	6,095	5,079	4,354	3,810	3,386	3,048	2,771	2,540	2,344	2,177	1,905	1,693	1,481	1,269				
				D	0.034	0.054	0.077	0.105	0.137	0.174	0.214	0.259	0.309	0.362	0.420	0.479	0.538	0.597	0.656				
2 x 3/16	36.0	10'-1"	3.429 3.429	U	11,429	7,314	5,079	3,732	2,857	2,258	1,829	1,511	1,270	1,082	933	714	564						
				D	0.043	0.067	0.096	0.131	0.171	0.217	0.268	0.324	0.386	0.453	0.525	0.600	0.686	0.772					
				C	11,429	9,143	7,619	6,531	5,714	5,079	4,571	4,156	3,810	3,517	3,265	2,857	2,540	2,223	1,906				
				D	0.034	0.054	0.077	0.105	0.137	0.174	0.214	0.259	0.309	0.362	0.420	0.479	0.538	0.597	0.656				
2-1/4 x 3/16	40.5	11'-1"	4.339 4.882	U	14,464	9,257	6,429	4,723	3,616	2,857	2,314	1,913	1,607	1,369	1,181	904	714						
				D	0.038	0.060	0.086	0.117	0.152	0.193	0.238	0.288	0.343	0.402	0.467	0.532	0.597	0.662					
				C	14,464	11,571	9,643	8,265	7,232	6,429	5,786	5,260	4,821	4,451	4,133	3,616	3,214	2,812	2,410				
				D	0.030	0.048	0.069	0.093	0.122	0.154	0.190	0.230	0.274	0.322	0.373	0.424	0.475	0.526	0.577				
2-1/2 x 3/16	44.9	12'-0"	5.357 6.696	U	17,857	11,429	7,937	5,831	4,464	3,527	2,857	2,361	1,984	1,691	1,458	1,116	882						
				D	0.034	0.054	0.077	0.105	0.137	0.174	0.214	0.259	0.309	0.362	0.420	0.479	0.538	0.597					
				C	17,857	14,286	11,905	10,204	8,929	7,937	7,143	6,494	5,952	5,495	5,102	4,464	3,968	3,472	2,976				
				D	0.027	0.043	0.062	0.084	0.110	0.139	0.171	0.207	0.247	0.290	0.336	0.382	0.428	0.474	0.520				

\* Weight per square foot based upon 7-SLS-4 grating. Add .30 psf for 2" on center cross bars. \*\* Maximum pedestrian load is defined as a 100# uniform load with deflection ≤ 1/4 inch. (The 1/4" maximum deflection criteria is considered consistent with pedestrian comfort, but may be exceeded for other loading conditions at the discretion of the specifying authority.) \*\*\* Section properties per foot of width.

Note: When gratings with serrated surface are specified, the depth of the grating required for a specific load will be 1/4" greater than that shown in these tables.

### Panel Widths

Grating panels are available from stock in nominal 24" and 36" widths. When considering alternative widths, consult this table to select widths that will maintain uniform "out-to-out" spacing of the bearing bars. Specified widths deviating from this table will be fabricated to size with side banding and the bar spacing on one side of the finished panel will vary from the spacing throughout the remainder of the panel.

Number of Bearing Bars	2	3	4	5	6	7	8	9	10	11	12	13	14	15	16
Panel Width	5/8"	1-1/16"	1-1/2"	1-15/16"	2-3/8"	2-13/16"	3-1/4"	3-11/16"	4-1/8"	4-9/16"	5"	5-7/16"	5-7/8"	6-5/16"	6-3/4"
17	18	19	20	21	22	23	24	25	26	27	28	29	30	31	31
Panel Width	7-3/16"	7-5/8"	8-1/16"	8-1/2"	8-15/16"	9-3/8"	9-13/16"	10-1/4"	10-11/16"	11-1/8"	11-9/16"	12"	12-7/16"	12-7/8"	13-5/16"
32	33	34	35	36	37	38	39	40	41	42	43	44	45	46	46
Panel Width	13-3/4"	14-3/16"	14-5/8"	15-1/16"	15-1/2"	15-15/16"	16-3/8"	16-13/16"	17-1/4"	17-11/16"	18-1/8"	18-9/16"	19"	19-7/16"	19-7/8"
47	48	49	50	51	52	53	54	55	56	57	58	59	60	61	61
Panel Width	20-5/16"	20-3/4"	21-3/16"	21-5/8"	22-1/16"	22-1/2"	22-15/16"	23-3/8"	23-13/16"	24-1/4"	24-11/16"	25-1/8"	25-9/16"	26"	26-7/16"
62	63	64	65	66	67	68	69	70	71	72	73	74	75	76	76
Panel Width	26-3/4"	27-5/16"	27-3/4"	28-3/16"	28-5/8"	29-1/16"	29-1/2"	29-15/16"	30-3/8"	30-13/16"	31-1/4"	31-11/16"	32-1/8"	32-9/16"	33"
77	78	79	80	81	82	83									
Panel Width	33-7/16"	33-7/8"	34-5/16"	34-3/4"	35-3/16"	35-5/8"	36-1/16"								

Panel widths indicated are for gratings with 3/16" thick bearing bars. For 1/8" thick bearing bars deduct 1/16" from the stated values.

■ Indicates stock panel widths.

# Stainless Steel Stair Treads

## Stainless Steel Stair Treads

Stainless steel stair treads are available fabricated to any size in type "WS" welded, type "DTS" dovetail pressure locked, or type "SLS" swage locked grating. Treads are manufactured with a defined visible nosing and pre-punched end carrier plates or angles, ready for bolting or welding to the stair stringers.

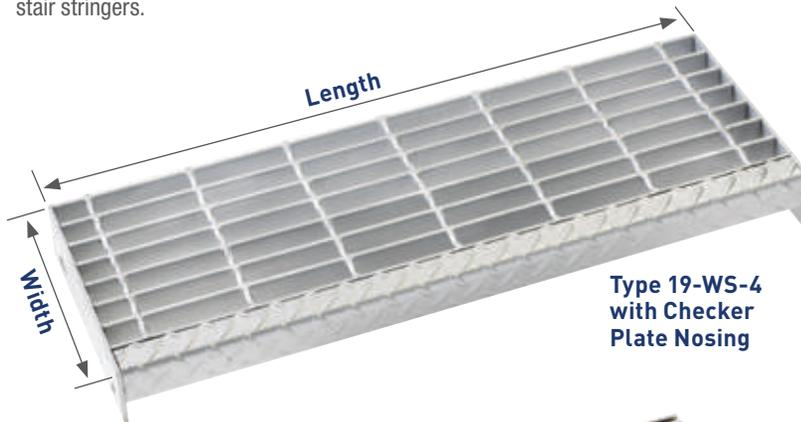

**Type 19-WS-4 with Checker Plate Nosing**

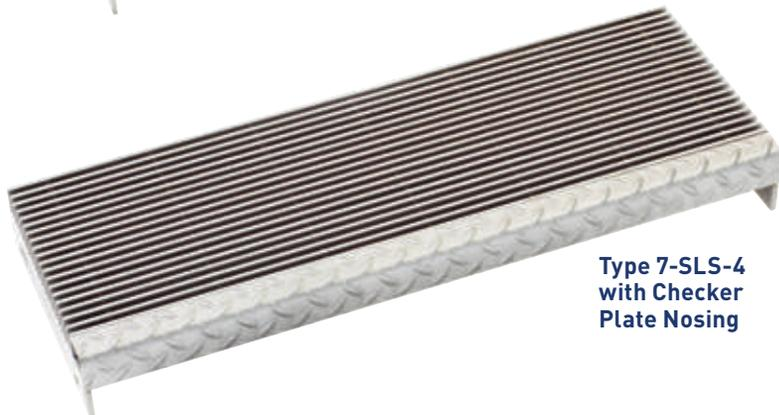

**Type 7-SLS-4 with Checker Plate Nosing**

## Stainless Steel Carrier Plates & Angles

### Stainless Steel Carrier Plates

Recommended for use with 19, 15, and 11 spaced gratings

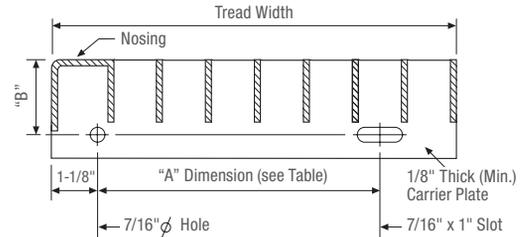

"B" Dimension  
 1-3/4" for 3/4" thru 1-1/4" bearing bars  
 2-1/4" for 1-1/2" thru 1-3/4" bearing bars  
 3-1/4" for 2" thru 2-1/2" bearing bars

### Stainless Steel Carrier Angles

Recommended for use with 8 and 7 spaced gratings

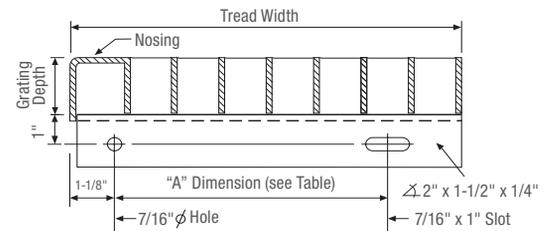

### Nosing Options



Checker plate nosing welded to grating and carrier plates/angles.

Algrip nosing welded to grating and carrier plates/angles.

## Table of Stair Tread Widths

19 Space			15 Space			11 Space			8 Space			7 Space		
Bearing Bars @ 1-3/16" O.C.			Bearing Bars @ 15/16" O.C.			Bearing Bars @ 11/16" O.C.			Bearing Bars @ 1/2" O.C.			Bearing Bars @ 7/16" O.C.		
Nominal Tread Width	Number of Bearing Bars	Standard "A" Dimension	Nominal Tread Width	Number of Bearing Bars	Standard "A" Dimension	Nominal Tread Width	Number of Bearing Bars	Standard "A" Dimension	Nominal Tread Width	Number of Bearing Bars	Standard "A" Dimension	Nominal Tread Width	Number of Bearing Bars	Standard "A" Dimension
6-1/4"	5	2-1/2"	7"	7	4-1/2"	6-1/4"	8	2-1/2"	6-1/2"	11	2-1/2"	6-3/4"	13	2-1/2"
7-3/8"	6	4-1/2"	8"	8	4-1/2"	7-5/8"	10	4-1/2"	7-1/2"	13	4-1/2"	7-5/8"	15	4-1/2"
8-1/2"	7	4-1/2"	8-7/8"	9	4-1/2"	9"	12	4-1/2"	9"	16	4-1/2"	8-1/2"	17	4-1/2"
9-3/4"	8	7"	9-7/8"	10	7"	10-3/8"	14	7"	10"	18	7"	10-1/8"	21	7"
11"	9	7"	10-3/4"	11	7"	11"	15	7"	11"	20	7"	11-1/8"	23	7"
12-1/8"	10	7"	11-5/8"	12	7"	11-3/4"	16	7"	12"	22	7"	12"	25	7"

## Recommended Maximum Stainless Steel Stair Tread Lengths\*

Bearing Bar Size	19 Space		15 Space		11 Space		8 Space		7 Space	
	1-3/16" O.C.		15/16" O.C.		11/16" O.C.		1/2" O.C.		7/16" O.C.	
	Plain	Serrated	Plain	Serrated	Plain	Serrated	Plain	Serrated	Plain	Serrated
3/4" x 3/16"	2'-7"	—	3'-0"	—	3'-3"	—	3'-7"	—	3'-9"	—
1" x 3/16"	3'-8"	3'-2"	3'-11"	—	4'-2"	—	4'-10"	4'-2"	5'-1"	4'-4"
1-1/4" x 3/16"	4'-7"	4'-1"	5'-2"	—	5'-5"	—	4'-9"	5'-6"	5'-6"	5'-6"
1-1/2" x 3/16"	5'-6"	5'-2"	5'-6"	—	5'-6"	—	5'-7"	5'-6"	5'-9"	5'-6"
1-3/4" x 3/16"	5'-6"	5'-6"	5'-7"	—	5'-6"	—	6'-5"	6'-0"	6'-8"	6'-3"
2" x 3/16"	5'-10"	5'-6"	6'-4"	—	5'-11"	—	7'-4"	6'-10"	7'-7"	7'-2"
2-1/4" x 3/16"	6'-7"	6'-3"	7'-0"	—	6'-8"	—	8'-2"	7'-9"	8'-6"	8'-1"
2-1/2" x 3/16"	7'-3"	6'-11"	7'-10"	—	7'-5"	—	9'-1"	8'-8"	9'-5"	9'-0"

\* For treads up to 5'-6", maximum tread lengths are based upon 300 lb. concentrated load on the front 5 inches of the tread, at the center of the tread length. When treads exceed 5'-6" in length, design allows for 300 lb. concentrated loads at 1/3 points of tread length. Deflection is limited to the lesser of .250" or 1/240 of tread length in all cases.

# Riveted Grating

**Riveted Gratings** are manufactured by cold-press riveting straight bearing bars to crimped rectangular flat bars. The oldest form of grating, riveted products offer superior resistance to impact, fatigue and repetitive loads.

## Materials

Riveted gratings are available in carbon steel, 6000 series aluminum, and 300 series stainless steels. These products are manufactured with bearing bars spaced either 1-1/8" or 3/4" apart and the standard rivet spacing is 7 inches on center. Optional close rivet spacing of 3-1/2" on center is also available.



Type 18-R-7



## Serrated Surface

The standard method of manufacturing serrated riveted grating is to serrate the crimped cross member. When assembled, these cross members are raised slightly above the top surface of the bearing bars to provide a superior unidirectional slip-resistant surface.

If your application is particularly prone to unsafe walking conditions, consider specifying "100% Serrated" grating where both the bearing bars and cross members are provided with serrations.

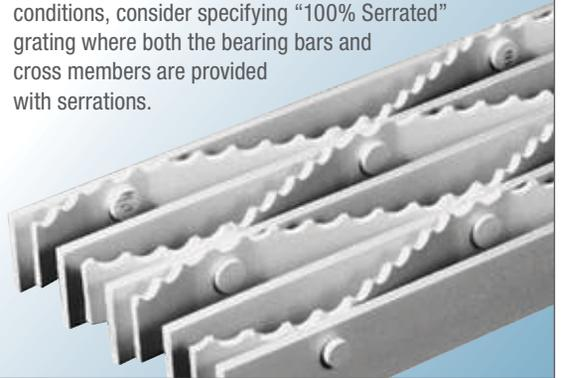

## Table of Spacings Available

18-R-7

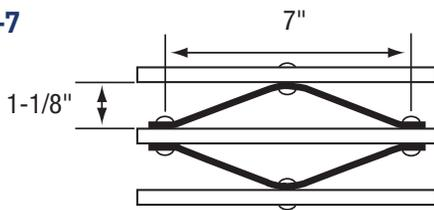

12-R-7

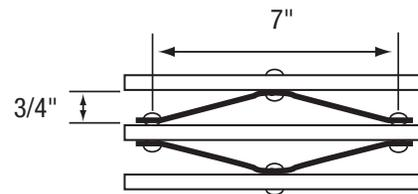

18-R-3.5

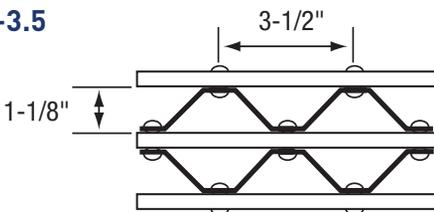

12-R-3.5

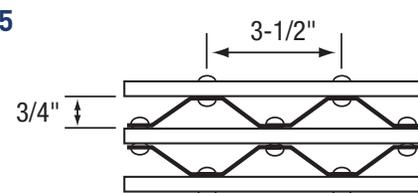

The part numbers shown above are for carbon steel riveted gratings.

To specify aluminum or stainless steel products, replace the alpha character "R" with "AR" for aluminum products or "SR" for stainless steel products.

## Examples:

Type 18-AR-7 for riveted aluminum grating with bearing bars 1-1/8" apart and rivets at 7" on center.

Type 12-SR-7 for stainless steel riveted grating with bearing bars 3/4" apart and rivets at 7" on center.

## 18 Space (1-1/8") Steel Load Table

Use this table when evaluating spans and loads for the following types of steel grating:  
**18-R-7 and 18-R-3.5**

Bearing Bar Size (inches)	Approx. Weight psf *	Maximum Pedestrian Span**		Unsupported Span											
				2'-0	2'-6	3'-0	3'-6	4'-0	4'-6	5'-0	5'-6	6'-0	6'-6	7'-0	8'-0
3/4 x 3/16	7.8	4'-0"	U	613	392	272	200	153	121	98	All loads and deflections are theoretical and based upon the gross sections of the bearing bars, using a fiber stress of 18,000 psi.  The values are not intended to be absolute since the actual load capacity will be affected by the slight variations in mill and manufacturing tolerances.  Grating for spans to the left of the heavy line have a deflection $\leq 1/4"$ for uniform loads of 100 psf.  U = uniform load in pounds/sq. ft. C = concentrated load in pounds/ft. of grating width D = deflection in inches				
			D	0.099	0.155	0.223	0.304	0.397	0.503	0.621					
			C	613	490	409	350	306	272	245					
			D	0.079	0.124	0.179	0.243	0.318	0.402	0.497					
1 x 1/8	7.6	4'-5"	U	726	465	323	237	182	144	116					
			D	0.074	0.116	0.168	0.228	0.298	0.377	0.466					
			C	726	581	484	415	363	323	291					
			D	0.060	0.093	0.134	0.182	0.238	0.302	0.372					
1 x 3/16	9.4	4'-11"	U	1,090	697	484	356	272	215	174	144				
			D	0.074	0.116	0.168	0.228	0.298	0.377	0.466	0.563				
			C	1,090	872	726	623	545	484	436	396				
			D	0.060	0.093	0.134	0.182	0.238	0.302	0.372	0.451				
1-1/4 x 1/8	8.7	5'-3"	U	1,135	726	504	371	284	224	182	150	126			
			D	0.060	0.093	0.134	0.182	0.238	0.302	0.372	0.451	0.536			
			C	1,135	908	757	649	567	504	454	413	378			
			D	0.048	0.074	0.107	0.146	0.191	0.241	0.298	0.360	0.429			
1-1/4 x 3/16	11.0	5'-10"	U	1,702	1,090	757	556	426	336	272	225	189	161		
			D	0.060	0.093	0.134	0.182	0.238	0.302	0.372	0.451	0.536	0.629		
			C	1,702	1,362	1,135	973	851	757	681	619	567	524		
			D	0.048	0.074	0.107	0.146	0.191	0.241	0.298	0.360	0.429	0.504		
1-1/2 x 1/8	9.9	6'-0"	U	1,634	1,046	726	534	409	323	262	216	182	155	133	102
			D	0.050	0.078	0.112	0.152	0.199	0.251	0.310	0.376	0.447	0.524	0.608	0.794
			C	1,634	1,307	1,090	934	817	726	654	594	545	503	467	409
			D	0.040	0.062	0.089	0.122	0.159	0.201	0.248	0.300	0.358	0.420	0.487	0.636
1-1/2 x 3/16	12.5	6'-8"	U	2,451	1,569	1,090	800	613	484	392	324	272	232	200	153
			D	0.050	0.078	0.112	0.152	0.199	0.251	0.310	0.376	0.447	0.524	0.608	0.794
			C	2,451	1,961	1,634	1,401	1,226	1,090	981	891	817	754	700	613
			D	0.040	0.062	0.089	0.122	0.159	0.201	0.248	0.300	0.358	0.420	0.487	0.636
1-3/4 x 3/16	14.2	7'-6"	U	3,337	2,135	1,483	1,090	834	659	534	441	371	316	272	209
			D	0.043	0.067	0.096	0.130	0.170	0.215	0.266	0.322	0.383	0.450	0.521	0.681
			C	3,337	2,669	2,224	1,907	1,668	1,483	1,335	1,213	1,112	1,027	953	834
			D	0.034	0.053	0.077	0.104	0.136	0.172	0.213	0.257	0.306	0.360	0.417	0.545
2 x 3/16	16.8	8'-3"	U	4,358	2,789	1,937	1,423	1,090	861	697	576	484	413	356	272
			D	0.037	0.058	0.084	0.114	0.149	0.189	0.233	0.282	0.335	0.393	0.456	0.596
			C	4,358	3,486	2,905	2,490	2,179	1,937	1,743	1,585	1,453	1,341	1,245	1,090
			D	0.030	0.047	0.067	0.091	0.119	0.151	0.186	0.225	0.268	0.315	0.365	0.477
2-1/4 x 3/16	18.3	9'-0"	U	5,515	3,530	2,451	1,801	1,379	1,090	883	729	613	522	450	345
			D	0.033	0.052	0.074	0.101	0.132	0.168	0.207	0.250	0.298	0.350	0.406	0.530
			C	5,515	4,412	3,677	3,152	2,758	2,451	2,206	2,006	1,839	1,697	1,576	1,379
			D	0.026	0.041	0.060	0.081	0.106	0.134	0.166	0.200	0.238	0.280	0.324	0.424
2-1/2 x 3/16	19.9	9'-9"	U	6,809	4,358	3,026	2,223	1,702	1,345	1,090	900	757	645	556	426
			D	0.030	0.047	0.067	0.091	0.119	0.151	0.186	0.225	0.268	0.315	0.365	0.477
			C	6,809	5,447	4,540	3,891	3,405	3,026	2,724	2,476	2,270	2,095	1,946	1,702
			D	0.024	0.037	0.054	0.073	0.095	0.121	0.149	0.180	0.215	0.252	0.292	0.381

\* Weight per square foot based upon rivets spaced at 7" on center. Add .40 psf for 3-1/2" rivet centers.

\*\* Maximum pedestrian load is defined as a 100# uniform load with deflection  $\leq 1/4$  inch. The 1/4" maximum deflection criteria is considered consistent with pedestrian comfort, but may be exceeded for other loading conditions at the discretion of the specifying authority.

# Riveted Grating

## 18 Space (1-1/8") Aluminum Load Table

Use this table when evaluating spans and loads for the following types of aluminum grating:  
**18-AR-7 and 18-AR-3.5**

Bearing Bar Size (inches)	Approx. Weight psf *	Maximum Pedestrian Span**		Unsupported Span													
				2'-0	2'-6	3'-0	3'-6	4'-0	4'-6	5'-0	5'-6	6'-0	6'-6	7'-0	8'-0		
1 x 1/8	2.7	3'-5"	U	484	310	215	158	121	All loads and deflections are theoretical and based upon the gross sections of the bearing bars, using a fiber stress of 12,000 psi.  The values are not intended to be absolute since the actual load capacity will be affected by the slight variations in mill and manufacturing tolerances.  Grating for spans to the left of the heavy line have a deflection ≤ 1/4" for uniform loads of 100 psf.  U = uniform load in pounds/sq. ft. C = concentrated load in pounds/foot of grating width D = deflection in inches								
			D	0.144	0.225	0.324	0.441	0.576									
			C	484	387	323	277	242									
			D	0.115	0.180	0.259	0.353	0.461									
1 x 3/16	3.3	3'-9"	U	726	465	323	237	182	144								
			D	0.144	0.225	0.324	0.441	0.576	0.729								
			C	726	581	484	415	363	323								
			D	0.115	0.180	0.259	0.353	0.461	0.583								
1-1/4 x 1/8	3.1	4'-0"	U	757	484	336	247	189	149	121							
			D	0.115	0.180	0.259	0.353	0.461	0.583	0.720							
			C	757	605	504	432	378	336	303							
			D	0.092	0.144	0.207	0.282	0.369	0.467	0.576							
1-1/4 x 3/16	3.8	4'-5"	U	1,135	726	504	371	284	224	182							
			D	0.115	0.180	0.259	0.353	0.461	0.583	0.720							
			C	1,135	908	757	649	567	504	454							
			D	0.092	0.144	0.207	0.282	0.369	0.467	0.576							
1-1/2 x 1/8	3.4	4'-7"	U	1,090	697	484	356	272	215	174	144						
			D	0.096	0.150	0.216	0.294	0.384	0.486	0.600	0.726						
			C	1,090	872	726	623	545	484	436	396						
			D	0.077	0.120	0.173	0.235	0.307	0.389	0.480	0.581						
1-1/2 x 3/16	4.4	5'-1"	U	1,634	1,046	726	534	409	323	262	216	182					
			D	0.096	0.150	0.216	0.294	0.384	0.486	0.600	0.726	0.864					
			C	1,634	1,307	1,090	934	817	726	654	594	545					
			D	0.077	0.120	0.173	0.235	0.307	0.389	0.480	0.581	0.691					
1-3/4 x 3/16	4.9	5'-9"	U	2,224	1,424	989	726	556	439	356	294	247	211				
			D	0.082	0.129	0.185	0.252	0.329	0.417	0.514	0.622	0.741	0.869				
			C	2,224	1,780	1,483	1,271	1,112	989	890	809	741	684				
			D	0.066	0.103	0.148	0.202	0.263	0.333	0.411	0.498	0.592	0.695				
2 x 3/16	5.8	6'-4"	U	2,905	1,859	1,291	949	726	574	465	384	323	275	237			
			D	0.072	0.113	0.162	0.221	0.288	0.365	0.450	0.545	0.648	0.761	0.882			
			C	2,905	2,324	1,937	1,660	1,453	1,291	1,162	1,057	968	894	830			
			D	0.058	0.090	0.130	0.176	0.230	0.292	0.360	0.436	0.518	0.608	0.706			
2-1/4 x 3/16	6.4	6'-11"	U	3,677	2,353	1,634	1,201	919	726	588	486	409	348	300	230		
			D	0.064	0.100	0.144	0.196	0.256	0.324	0.400	0.484	0.576	0.676	0.784	1.024		
			C	3,677	2,942	2,451	2,101	1,839	1,634	1,471	1,337	1,226	1,131	1,051	919		
			D	0.051	0.080	0.115	0.157	0.205	0.259	0.320	0.387	0.461	0.541	0.627	0.819		
2-1/2 x 3/16	6.9	7'-6"	U	4,540	2,905	2,018	1,482	1,135	897	726	600	504	430	371	284		
			D	0.058	0.090	0.130	0.176	0.230	0.292	0.360	0.436	0.518	0.608	0.706	0.922		
			C	4,540	3,632	3,026	2,594	2,270	2,018	1,816	1,651	1,513	1,397	1,297	1,135		
			D	0.046	0.072	0.104	0.141	0.184	0.233	0.288	0.348	0.415	0.487	0.564	0.737		

\* Weight per square foot based upon rivets spaced at 7" on center. Add .20 psf for 3-1/2" rivet centers.

\*\* Maximum pedestrian load is defined as a 100# uniform load with deflection ≤ 1/4 inch. The 1/4" maximum deflection criteria is considered consistent with pedestrian comfort, but may be exceeded for other loading conditions at the discretion of the specifying authority.

Use this table when evaluating spans and loads for the following types of steel grating:  
**12-R-7 and 12-R-3.5**

## 12 Space (3/4") Steel Load Table

Bearing Bar Size (inches)	Approx. Weight psf *	Maximum Pedestrian Span**	Unsupported Span												
			2'-0	2'-6	3'-0	3'-6	4'-0	4'-6	5'-0	5'-6	6'-0	6'-6	7'-0	8'-0	
3/4 x 3/16	10.7	4'-4"	U	858	549	381	280	215	170	All loads and deflections are theoretical and based upon the gross sections of the bearing bars, using a fiber stress of 18,000 psi.  The values are not intended to be absolute since the actual load capacity will be affected by the slight variations in mill and manufacturing tolerances.  Grating for spans to the left of the heavy line have a deflection $\leq 1/4"$ for uniform loads of 100 psf.					
			D	0.099	0.155	0.223	0.304	0.397	0.503						
			C	858	686	572	490	429	381						
1 x 3/16	12.8	5'-4"	U	1,525	976	678	498	381	301	244	202	The values are not intended to be absolute since the actual load capacity will be affected by the slight variations in mill and manufacturing tolerances.  Grating for spans to the left of the heavy line have a deflection $\leq 1/4"$ for uniform loads of 100 psf.			
			D	0.074	0.116	0.168	0.228	0.298	0.377	0.466	0.563				
			C	1,525	1,220	1,017	872	763	678	610	555				
1-1/4 x 3/16	15.0	6'-4"	U	2,383	1,525	1,059	778	596	471	381	315	265	226	U = uniform load in pounds/sq. ft. C = concentrated load in pounds/ft. of grating width D = deflection in inches	
			D	0.060	0.093	0.134	0.182	0.238	0.302	0.372	0.451	0.536	0.629		
			C	2,383	1,907	1,589	1,362	1,192	1,059	953	867	794	733		
1-1/2 x 3/16	17.1	7'-3"	U	3,432	2,196	1,525	1,121	858	678	549	454	381	325	280	215
			D	0.050	0.078	0.112	0.152	0.199	0.251	0.310	0.376	0.447	0.524	0.608	0.794
			C	3,432	2,745	2,288	1,961	1,716	1,525	1,373	1,248	1,144	1,056	981	858
1-3/4 x 3/16	19.4	8'-2"	U	4,671	2,989	2,076	1,525	1,168	923	747	618	519	442	381	292
			D	0.043	0.067	0.096	0.130	0.170	0.215	0.266	0.322	0.383	0.450	0.521	0.681
			C	4,671	3,737	3,114	2,669	2,336	2,076	1,868	1,699	1,557	1,437	1,335	1,168
2 x 3/16	22.9	9'-0"	U	6,101	3,905	2,712	1,992	1,525	1,205	976	807	678	578	498	381
			D	0.037	0.058	0.084	0.114	0.149	0.189	0.233	0.282	0.335	0.393	0.456	0.596
			C	6,101	4,881	4,067	3,486	3,050	2,712	2,440	2,219	2,034	1,877	1,743	1,525
2-1/4 x 3/16	25.0	9'-10"	U	7,721	4,942	3,432	2,521	1,930	1,525	1,235	1,021	858	731	630	483
			D	0.033	0.052	0.074	0.101	0.132	0.168	0.207	0.250	0.298	0.350	0.406	0.530
			C	7,721	6,177	5,148	4,412	3,861	3,432	3,089	2,808	2,574	2,376	2,206	1,930
2-1/2 x 3/16	27.2	10''-8"	U	9,533	6,101	4,237	3,113	2,383	1,883	1,525	1,261	1,059	903	778	596
			D	0.030	0.047	0.067	0.091	0.119	0.151	0.186	0.225	0.268	0.315	0.365	0.477
			C	9,533	7,626	6,355	5,447	4,766	4,237	3,813	3,466	3,178	2,933	2,724	2,383
			D	0.024	0.037	0.054	0.073	0.095	0.121	0.149	0.180	0.215	0.252	0.292	0.381

Use this table when evaluating spans and loads for the following types of aluminum grating:  
**12-AR-7 and 12-AR-3.5**

## 12 Space (3/4") Aluminum Load Table

Bearing Bar Size (inches)	Approx. Weight psf *	Maximum Pedestrian Span**	Unsupported Span													
			2'-0	2'-6	3'-0	3'-6	4'-0	4'-6	5'-0	5'-6	6'-0	6'-6	7'-0	8'-0		
3/4 x 3/16	3.7	3'-3"	U	572	366	254	187	143	113	92	All loads and deflections are theoretical and based upon the gross sections of the bearing bars, using a fiber stress of 12,000 psi.  The values are not intended to be absolute since the actual load capacity will be affected by the slight variations in mill and manufacturing tolerances.  Grating for spans to the left of the heavy line have a deflection $\leq 1/4"$ for uniform loads of 100 psf.					
			D	0.192	0.300	0.432	0.588	0.768	0.972	1.200						
			C	572	458	381	327	286	254	229						
1 x 3/16	4.5	4'-1"	U	1,017	651	452	332	254	201	163	The values are not intended to be absolute since the actual load capacity will be affected by the slight variations in mill and manufacturing tolerances.  Grating for spans to the left of the heavy line have a deflection $\leq 1/4"$ for uniform loads of 100 psf.					
			D	0.144	0.225	0.324	0.441	0.576	0.729	0.900						
			C	1,017	813	678	581	508	452	407						
1-1/4 x 3/16	5.3	4'-10"	U	1,589	1,017	706	519	397	314	254	210	U = uniform load in pounds/sq. ft. C = concentrated load in pounds/ft. of grating width D = deflection in inches				
			D	0.115	0.180	0.259	0.353	0.461	0.583	0.720	0.871					
			C	1,589	1,271	1,059	908	794	706	636	578					
1-1/2 x 3/16	6.1	5'-7"	U	2,288	1,464	1,017	747	572	452	366	303	254	217			
			D	0.096	0.150	0.216	0.294	0.384	0.486	0.600	0.726	0.864	1.014			
			C	2,288	1,830	1,525	1,307	1,144	1,017	915	832	763	704			
1-3/4 x 3/16	6.8	6'-3"	U	3,114	1,993	1,384	1,017	779	615	498	412	346	295	254	195	
			D	0.082	0.129	0.185	0.252	0.329	0.417	0.514	0.622	0.741	0.869	1.008	1.317	
			C	3,114	2,491	2,076	1,779	1,557	1,384	1,246	1,132	1,038	958	890	779	
2 x 3/16	8.1	6'-11"	U	4,067	2,603	1,808	1,328	1,017	803	651	538	452	385	332	254	
			D	0.072	0.113	0.162	0.221	0.288	0.365	0.450	0.545	0.648	0.761	0.882	1.152	
			C	4,067	3,254	2,712	2,324	2,034	1,808	1,627	1,479	1,356	1,252	1,162	1,017	
2-1/4 x 3/16	8.9	7'-6"	U	5,148	3,295	2,288	1,681	1,287	1,017	824	681	572	487	420	322	
			D	0.064	0.100	0.144	0.196	0.256	0.324	0.400	0.484	0.576	0.676	0.784	1.024	
			C	5,148	4,118	3,432	2,942	2,574	2,288	2,059	1,872	1,716	1,584	1,471	1,287	
2-1/2 x 3/16	9.6	8'-2"	U	6,355	4,067	2,825	2,075	1,589	1,255	1,017	840	706	602	519	397	
			D	0.058	0.090	0.130	0.176	0.230	0.292	0.360	0.436	0.518	0.608	0.706	0.922	
			C	6,355	5,084	4,237	3,632	3,178	2,825	2,542	2,311	2,118	1,955	1,816	1,589	
			D	0.046	0.072	0.104	0.141	0.184	0.233	0.288	0.348	0.415	0.487	0.564	0.737	

\* Weight per square foot based upon rivets spaced at 7" on center. Add .40 psf for steel products with 3-1/2" rivet centers and .20 psf for aluminum products with 3-1/2" rivet centers.

\*\* Maximum pedestrian load is defined as a 100# uniform load with deflection  $\leq 1/4$  inch. The 1/4" maximum deflection criteria is considered consistent with pedestrian comfort, but may be exceeded for other loading conditions at the discretion of the specifying authority.

# ALGRIP™ Grating & Floor Plate



## Workplace Safety

Workplace safety is a must for employers and employees alike. Spiraling costs related to workplace injuries include lost productivity, medical expenses, increased workers compensation insurance premiums, and disability payments. For enhanced safety, all Grating Pacific bar grating products are available with a slip-resistant Algrip walking surface.

When applications require a solid floor, Algrip Slip-Resistant Floor Plate is often a preferred option. Available in carbon steel, stainless steel, and aluminum, these products provide superior performance when compared to diamond floor plate or applied slip-resistant coatings.

## Surface Application

The Algrip surface is applied through a patented CNC laser deposition process in which hundreds of rugged, custom alloy, slip-resistant laser deposits are delivered to each square foot of the substrate. This surface can be applied to all materials commonly used to manufacture bar gratings and floor plates.



## Slip Resistance & Coefficient of Friction

Slip-resistance is commonly tested in a laboratory setting by measuring for static coefficient of friction (COF) in accordance with ASTM procedure C-1028. This testing procedure assigns a value to the traction surface while that surface is tested under wet and dry conditions. The results of these tests are expressed in numerical values with higher values indicating increased slip-resistance.

The Occupational Safety and Health Administration (OSHA) recommends that walking surfaces maintain a minimum COF of 0.50. The Americans with Disabilities Act (ADA) recommends that level walking surfaces maintain a 0.60 COF and that inclined ramps maintain a more stringent 0.80 COF.

The results indicated in the table to the right demonstrate that Algrip plate and grating products exceed these published guidelines in all conditions.

### STATIC COF

OSHA Guidelines	All surfaces	0.50 COF recommended
ADA Guidelines	Level surfaces Inclined ramps	0.60 COF recommended 0.80 COF recommended
Algrip™ Test Results (ASTM Procedure C-1028-89)	Dry leather	0.88 COF
	Dry rubber	0.94 COF
	Dry neolite	0.97 COF
	Wet leather	0.91 COF
	Wet rubber	0.92 COF
	Wet neolite	0.96 COF

## Durability

The traction providing laser deposits of Algrip have been tested for hardness and adherence by independent testing laboratories. Analysis has measured the hardness of the deposits at up to 60 on the Rockwell C Scale. Under repetitious pedestrian and vehicular traffic, these deposits provide continuous, safe, effective service.

The cross-sectional photograph illustrates the deep penetration of the symmetrical laser deposition into a steel substrate. The deposition penetrates the substrate and is enclosed by a heat affected zone. The resulting bond strength, combined with the proven deposition hardness provides unsurpassed durability regardless of wear or abrasion.

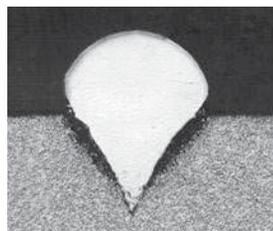

Cross-section of Algrip laser deposition magnified 32 times.

## Risk Reward Analysis

When you invest in Algrip, you have selected a superior floor surface that is virtually maintenance-free. Once installed, employees and employers are provided the highest level of protection from slips and falls.

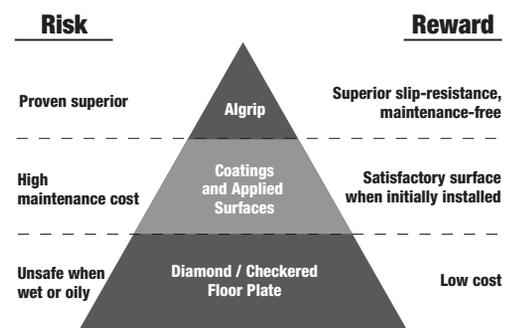

## Algrip Slip-Resistant Grating & Stair Treads

All Grating Pacific bar grating products are offered with the premium Algrip slip-resistant surface. Type “W” welded carbon steel or stainless steel, types “DT”, “SL” and “SG” steel, aluminum or stainless steel products, all available with our full variety of finishes.

### How to Specify Grating with Algrip Surface

#### 1. Specify type of grating:

- “W” for welded steel
- “SG” for rectangular bar aluminum
- “WS” for welded stainless steel
- “DT” for dovetail steel
- “ADT” for aluminum dovetail
- “DTS” for dovetail stainless steel
- “SL” for swage locked steel
- “SGF” for flush-top aluminum
- “SLS” for swage locked stainless steel

#### 2. Select bearing bar and cross bar spacings

Examples: 19-W-4, 7-SL-4, 15-SG-2, 11-SGF-4, 19-SLS-4, etc.

#### 3. Specify bearing bar size with Algrip Surface

Example: 1-1/4" x 3/16" with Algrip Surface

#### 4. Specify banding or additional trim

#### 5. Specify finish:

Bare, painted, hot dip galvanized, anodized, commercial clean, etc.

#### 6. Specify fasteners (if required) – see page 59

#### Sample for Carbon Steel type 19-W-4 welded grating:

Grating and stair treads shall be as manufactured by Grating Pacific, 3651 Sausalito Street, Los Alamitos, CA 90720, (800) 321-4314. Material shall be A-1011 carbon steel, grating type shall be 19-W-4, and bearing bars shall be 1-1/4" x 3/16" with Algrip surface. Grating shall be fabricated with open ends banded and hot dip galvanized after fabrication.



## Algrip Slip Resistant Floor Plate

Algrip Slip-Resistant Floor Plates have efficiently served industry for over 40 years. When work areas are subject to the accumulation of moisture, fluids, or lubricants, Algrip is your number one choice. Manufactured in thicknesses from 14 gauge to 1-1/2", Algrip Floor Plate is designed to serve applications where a solid, safe working surface is essential.

## Materials

**Types 304 and 316 Stainless Steel** – Popular in food processing and clean room environments. Virtually maintenance-free, these products provide unsurpassed slip-resistance in areas subject to the accumulation of moisture or debris. The properties of the stainless steel substrate facilitate compliance with FDA and USDA regulations.

**ASTM A-36 and A-1011 Carbon Steel** – Easily fabricated by bending, burning, and welding. Carbon steel products can be provided with a mill finish, painted, or hot dip galvanized after fabrication.

**ASTM B-221 Aluminum** – Available in types 3003 or 5052, aluminum Algrip is light in weight and resistant to atmospheric corrosion. Aluminum products are typically provided mill finish.



**For load tables and additional information on Algrip Slip Resistant products visit our website: [www.gratingpacific.com](http://www.gratingpacific.com)**

# Heavy Duty Grating

**Welded Heavy Duty Gratings** are designed to service applications subject to heavy rolling and static loads such as highways, plant floors, loading docks, inlet covers, and airports. Since conditions can range from smaller forklift to large truck or aircraft traffic, heavy duty gratings are manufactured in a wide range of bar sizes and spacings.



## Design Criteria

Vehicular loads are designed in conformance with current AASHTO specifications for classifications H-15 through H-25. Automobile and forklift loads are similarly evaluated with loads calculated and distributed in accordance with the "Maximum Traffic Conditions" presented on page 37. If your application is not adequately addressed by these load conditions, please contact our Engineering Department and we will gladly assist in the selection of an appropriate heavy duty grating for your specific need.

## Materials & Spacings

Heavy duty gratings are manufactured in carbon steel and 300 series stainless steels. Carbon steel products are available bare (no finish), painted with manufacturers standard paint, or hot dip galvanized.

Stainless steel products are available mill finish, commercially cleaned, or electro-polished.

Below you will find a table of spacings for our most popular products.

### Table of Spacings

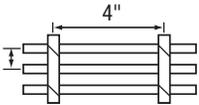
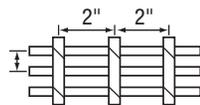
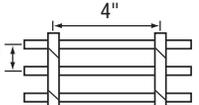
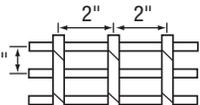
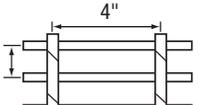
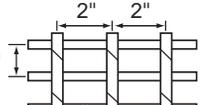
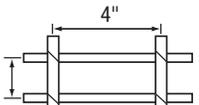
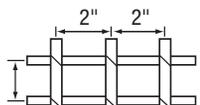
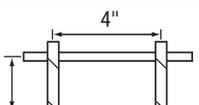
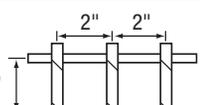
<b>15-W-4</b>	15/16" 	Bearing Bars at 15/16" O.C. Cross Bars at 4" O.C.	<b>15-W-2</b>	15/16" 	Bearing Bars at 15/16" O.C. Cross Bars at 2" O.C.
<b>19-W-4</b>	1- 3/16" 	Bearing Bars at 1-3/16" O.C. Cross Bars at 4" O.C.	<b>19-W-2</b>	1- 3/16" 	Bearing Bars at 1-3/16" O.C. Cross Bars at 2" O.C.
<b>22-W-4</b>	1-3/8" 	Bearing Bars at 1-3/8" O.C. Cross Bars at 4" O.C.	<b>22-W-2</b>	1- 3/8" 	Bearing Bars at 1-3/8" O.C. Cross Bars at 2" O.C.
<b>30-W-4</b>	1-7/8" 	Bearing Bars at 1-7/8" O.C. Cross Bars at 4" O.C.	<b>30-W-2</b>	1-7/8" 	Bearing Bars at 1-7/8" O.C. Cross Bars at 2" O.C.
<b>38-W-4</b>	2-3/8" 	Bearing Bars at 2-3/8" O.C. Cross Bars at 4" O.C.	<b>38-W-2</b>	2-3/8" 	Bearing Bars at 2-3/8" O.C. Cross Bars at 2" O.C.

Maximum Traffic Conditions	Wheel Load (lbs) (1/2 axle load + 30% impact)	Load Distribution	
		Parallel with Axle	Perpendicular to Axle
 <b>H-25</b> Truck Traffic 40,000 lb. Axle Load Dual Wheels Modified AASHTO H-25	26,000	2 (C)*+ 25"	25"
 <b>H-20</b> Truck Traffic 32,000 lb. Axle Load Dual Wheels Modified AASHTO H-20	20,800	2 (C)*+ 20"	20"
 <b>H-15</b> Truck Traffic 24,000 lb. Axle Load Dual Wheels Modified AASHTO H-15	15,600	2 (C)*+ 15"	15"
 <b>Automobile</b> Automobile Traffic 6,322 lb. Vehicle 3,578 lb. Load 60% Drive Axle Load	3,861	2 (C)*+ 9"	9"
 <b>5 Ton Forklift</b> 10,000 lb. Cap. Lift Truck 14,400 lb. Vehicle 24,400 lb. Total Load 85% Drive Axle Load	13,480	2 (C)*+11"	11"
 <b>3 Ton Forklift</b> 6,000 lb. Cap. Lift Truck 9,800 lb. Vehicle 15,800 lb. Total Load 85% Drive Axle Load	8,730	2 (C)*+7"	7"
 <b>1 Ton Forklift</b> 2,000 lb. Cap. Lift Truck 4,200 lb. Vehicle 6,200 lb. Total Load 85% Drive Axle Load	3,425	2 (C)*+4"	4"

\*C = Center-to-center spacing of bearing bars.

Allowable stress – 20,000 psi  
Modulus of elasticity – 29,000,000 psi

## Bearing Bar Selection

Once the bar spacing is selected, the bearing bar size must be specified based upon the load and unsupported clear span to be served. The tables on pages 38-42 provide the maximum clear span for our most popular products based on the traffic conditions defined on this page. These tables incorporate strict limitations where design deflection shall not exceed the lesser of L/400 or .125" for the spans indicated.

## Cross Bar Selection

While bearing bar selection is critical for specifying a proper heavy duty grating, the life cycle of your installation will often be influenced by the selection of the appropriate cross bar. The table below details the variety of cross bar sizes available.

The cross bars listed for Standard Loads are the customary twisted square or round cross bars supplied by Grating Pacific for a particular bearing bar size and spacing. These sizes have been selected to maximize manufacturing efficiency and are best used when the grating is subject to intermittent traffic with occasional full capacity loading.

The cross bars listed for Severe Loads are optional and will provide superior durability when gratings are subject to intense, continuous, or repetitious traffic. Ideal for trench covers, highways, and inlet grates, these cross bars enhance lateral stiffness thereby extending the service life of the grating. When specifying gratings with bearing bars centered at 1-3/8", 1-7/8", or 2-3/8" on center, consideration of Severe Loading cross bars is highly recommended.

**Note: In the event that a cross bar size is not specified, the cross bar shall be selected at the discretion of the manufacturer.**

Bearing Bar Size		BB Centers 15/16", 1-3/16", & 1-3/8"		BB Centers 1-7/8" & 2-3/8"	
Thickness	Depth	Standard Loads	Severe Loads	Standard Loads	Severe Loads
1/4"	1" - 2-1/2"	5/16" Twisted	5/16" Twisted	5/16" Twisted	5/16" Twisted
5/16"	1" - 2-1/2"	5/16" Twisted	5/16" Twisted	5/16" Twisted	5/16" Twisted
3/8"	1" - 2-1/2"	5/16" Twisted	5/16" Twisted	5/16" Twisted	5/16" Twisted
1/4"	3" - 5"	5/16" Twisted	1" x 1/4"	3/8" Round	1" x 1/4"
5/16" - 1/2"	3" - 5"	3/8" Round	1" x 3/8"	7/16" Round	1" x 3/8"
1/4"	5-1/2" - 7"	3/8" Round	1-1/4" x 1/4"	7/16" Round	1-1/4" x 1/4"
5/16" - 1/2"	5-1/2" - 7"	3/8" Round	1-1/4" x 3/8"	7/16" Round	1-1/4" x 3/8"

The sizes shown above are listed as minimums. Twisted and round cross bars are typically interchangeable and, unless otherwise specified, may be substituted at the discretion of the manufacturer. In substitution, the cross sectional area of the alternative cross bar shall equal or exceed the minimum size listed above.

## Banding

Heavy duty gratings are commonly subjected to shock and impact loads and it is highly recommended that all open ends be banded. The welded band bar helps distribute impact loads and minimizes distortion when subjected to repetitive traffic patterns. Banding details can be found on page 58.



## Serrated Surface

Optional serrated bearing bars enhance skid-resistance. Consider this surface for applications subject to the accumulation of liquids or lubricants or inclined installations.



## How to Specify Heavy Duty Bar Grating

- Select type of grating
  - "W" for welded steel grating
  - "WS" for welded stainless steel grating
- Select bar spacing from table on page 36
- Select bearing bar size from tables on pages 38-42
- Specify cross bar size from selection table above
- Specify plain or serrated surface
- Specify banding and any additional trim required
- Specify finish
  - Bare steel (no finish)
  - Painted (red, black, silver, other)
  - Hot dip galvanized (per ASTM A-123)
  - Other
- Specify fasteners (if required) – see page 59

# Heavy Duty Grating

## 15 Space (15/16") Load Table

Use this table when evaluating spans & loads for the following types of Heavy Duty steel grating:  
**15-W-4 and 15-W-2**



H-25 Load



H-20 Load



H-15 Load



Auto Traffic



5 Ton Forklift



3 Ton Forklift



1 Ton Forklift

Bearing Bar Size (inches)	Section Modulus per foot of width	Moment of Inertia per foot of width	Approx. Weight psf	Maximum Safe Span						
				H-25 Load	H-20 Load	H-15 Load	Auto Traffic	5 Ton Forklift	3 Ton Forklift	1 Ton Forklift
1 x 1/4	0.533	0.267	12.0	1'-1"	1'-0"	0'-10"	1'-2"	0'-8"	0'-7"	0'-8"
1 x 5/16	0.667	0.333	14.7	1'-3"	1'-2"	1'-0"	1'-5"	0'-9"	0'-8"	0'-9"
1 x 3/8	0.800	0.400	17.4	1'-4"	1'-3"	1'-1"	1'-7"	0'-10"	0'-8"	0'-11"
1-1/4 x 1/4	0.833	0.521	14.7	1'-4"	1'-3"	1'-1"	1'-8"	0'-10"	0'-9"	0'-11"
1-1/4 x 5/16	1.042	0.651	18.1	1'-6"	1'-5"	1'-3"	1'-11"	1'-0"	0'-10"	1'-1"
1-1/4 x 3/8	1.250	0.781	21.5	1'-8"	1'-6"	1'-4"	2'-1"	1'-1"	0'-11"	1'-4"
1-1/2 x 1/4	1.200	0.900	17.4	1'-8"	1'-6"	1'-4"	2'-3"	1'-1"	0'-11"	1'-3"
1-1/2 x 5/16	1.500	1.125	21.5	1'-10"	1'-8"	1'-6"	2'-6"	1'-3"	1'-1"	1'-7"
1-1/2 x 3/8	1.800	1.350	25.6	2'-0"	1'-10"	1'-8"	2'-9"	1'-4"	1'-3"	1'-10"
1-3/4 x 1/4	1.633	1.429	20.2	1'-11"	1'-9"	1'-7"	2'-10"	1'-3"	1'-2"	1'-8"
1-3/4 x 5/16	2.042	1.786	24.9	2'-2"	2'-0"	1'-10"	3'-2"	1'-6"	1'-5"	2'-1"
1-3/4 x 3/8	2.450	2.144	29.7	2'-5"	2'-3"	2'-1"	3'-6"	1'-9"	1'-8"	2'-6"
2 x 1/4	2.133	2.133	22.9	2'-3"	2'-0"	1'-10"	3'-6"	1'-7"	1'-5"	2'-2"
2 x 5/16	2.667	2.667	28.3	2'-6"	2'-4"	2'-2"	3'-11"	1'-10"	1'-9"	2'-8"
2 x 3/8	3.200	3.200	33.8	2'-10"	2'-8"	2'-6"	4'-3"	2'-1"	2'-1"	3'-2"
2-1/4 x 1/4	2.700	3.038	25.6	2'-7"	2'-4"	2'-2"	4'-2"	1'-10"	1'-9"	2'-8"
2-1/4 x 5/16	3.375	3.797	31.7	2'-11"	2'-9"	2'-7"	4'-5"	2'-2"	2'-2"	3'-4"
2-1/4 x 3/8	4.050	4.556	37.8	3'-4"	3'-2"	3'-0"	4'-9"	2'-7"	2'-6"	3'-11"
2-1/2 x 1/4	3.333	4.167	28.3	2'-11"	2'-9"	2'-7"	4'-7"	2'-2"	2'-2"	3'-4"
2-1/2 x 5/16	4.167	5.208	35.1	3'-5"	3'-3"	3'-1"	4'-11"	2'-8"	2'-7"	4'-1"
2-1/2 x 3/8	5.000	6.250	41.9	3'-10"	3'-9"	3'-7"	5'-3"	3'-1"	3'-1"	4'-5"
3 x 1/4	4.800	7.200	33.8	3'-9"	3'-7"	3'-6"	5'-6"	3'-0"	3'-0"	4'-8"
3 x 5/16	6.000	9.000	41.9	4'-5"	4'-4"	4'-2"	5'-11"	3'-7"	3'-8"	5'-0"
3 x 3/8	7.200	10.800	50.1	4'-8"	4'-7"	4'-7"	6'-4"	4'-3"	4'-4"	5'-4"
3-1/2 x 1/4	6.533	11.433	39.2	4'-9"	4'-7"	4'-6"	6'-5"	3'-11"	3'-11"	5'-5"
3-1/2 x 5/16	8.167	14.292	48.7	5'-1"	5'-1"	5'-1"	6'-11"	4'-9"	4'-10"	5'-10"
3-1/2 x 3/8	9.800	17.150	58.2	5'-5"	5'-4"	5'-5"	7'-4"	5'-2"	5'-3"	6'-3"
4 x 1/4	8.533	17.067	44.6	5'-4"	5'-4"	5'-4"	7'-4"	4'-11"	5'-1"	6'-3"
4 x 5/16	10.667	21.333	55.5	5'-9"	5'-9"	5'-9"	7'-11"	5'-6"	5'-8"	6'-8"
4 x 3/8	12.800	25.600	66.4	6'-1"	6'-1"	6'-2"	8'-5"	5'-11"	6'-0"	7'-2"
4-1/2 x 1/4	10.800	24.300	50.1	6'-0"	6'-0"	6'-0"	8'-3"	5'-9"	5'-11"	7'-0"
4-1/2 x 5/16	13.500	30.375	62.3	6'-6"	6'-6"	6'-6"	8'-11"	6'-3"	6'-4"	7'-7"
4-1/2 x 3/8	16.200	36.450	74.6	6'-10"	6'-10"	6'-11"	9'-6"	6'-7"	6'-9"	8'-0"
5 x 1/4	13.333	33.333	55.5	6'-8"	6'-8"	6'-9"	9'-2"	6'-5"	6'-7"	7'-9"
5 x 3/8	20.000	50.000	82.7	7'-7"	7'-8"	7'-8"	10'-6"	7'-4"	7'-6"	8'-11"
5 x 1/2	26.667	66.667	109.9	8'-4"	8'-5"	8'-5"	11'-7"	8'-1"	8'-3"	9'-10"
6 x 1/4	19.200	57.600	66.4	8'-0"	8'-0"	8'-1"	11'-1"	7'-8"	7'-10"	9'-4"
6 x 3/8	28.800	86.400	99.0	9'-1"	9'-2"	9'-2"	12'-8"	8'-10"	9'-0"	10'-9"
6 x 1/2	38.400	115.200	131.7	10'-0"	10'-1"	10'-2"	13'-11"	9'-9"	9'-11"	11'-10"
7 x 1/4	26.133	91.467	77.3	9'-3"	9'-4"	9'-5"	12'-11"	9'-0"	9'-2"	10'-11"
7 x 3/8	39.200	137.200	115.4	10'-7"	10'-8"	10'-9"	14'-9"	10'-4"	10'-6"	12'-6"
7 x 1/2	52.267	182.933	153.4	11'-8"	11'-9"	11'-10"	16'-3"	11'-4"	11'-7"	13'-9"

# Heavy Duty Grating

Use this table when evaluating spans & loads for the following types of Heavy Duty steel grating:  
**19-W-4 and 19-W-2**

## 19 Space (1-3/16") Load Table



H-25 Load



H-20 Load



H-15 Load



Auto Traffic



5 Ton Forklift



3 Ton Forklift



1 Ton Forklift

### Maximum Safe Span

Bearing Bar Size (inches)	Section Modulus per foot of width	Moment of Inertia per foot of width	Approx. Weight psf	Maximum Safe Span						
				H-25 Load	H-20 Load	H-15 Load	Auto Traffic	5 Ton Forklift	3 Ton Forklift	1 Ton Forklift
1 x 1/4	0.421	0.211	9.7	1'-0"	0'-10"	0'-9"	1'-0"	0'-7"	0'-6"	0'-7"
1 x 5/16	0.526	0.263	11.9	1'-1"	1'-0"	0'-10"	1'-2"	0'-8"	0'-7"	0'-8"
1 x 3/8	0.632	0.316	14.0	1'-2"	1'-1"	0'-11"	1'-4"	0'-9"	0'-8"	0'-9"
1-1/4 x 1/4	0.658	0.411	11.9	1'-3"	1'-1"	1'-0"	1'-5"	0'-9"	0'-8"	0'-10"
1-1/4 x 5/16	0.822	0.514	14.5	1'-4"	1'-3"	1'-1"	1'-8"	0'-10"	0'-9"	1'-0"
1-1/4 x 3/8	0.987	0.617	17.2	1'-6"	1'-4"	1'-2"	1'-11"	1'-0"	0'-10"	1'-2"
1-1/2 x 1/4	0.947	0.711	14.0	1'-6"	1'-4"	1'-2"	1'-11"	0'-11"	0'-10"	1'-1"
1-1/2 x 5/16	1.184	0.888	17.2	1'-8"	1'-6"	1'-4"	2'-3"	1'-1"	0'-11"	1'-4"
1-1/2 x 3/8	1.421	1.066	20.4	1'-10"	1'-8"	1'-6"	2'-6"	1'-2"	1'-1"	1'-7"
1-3/4 x 1/4	1.289	1.128	16.2	1'-9"	1'-7"	1'-5"	2'-5"	1'-2"	1'-0"	1'-5"
1-3/4 x 5/16	1.612	1.410	19.9	1'-11"	1'-9"	1'-7"	2'-11"	1'-4"	1'-3"	1'-9"
1-3/4 x 3/8	1.934	1.692	23.7	2'-2"	1'-11"	1'-9"	3'-2"	1'-6"	1'-5"	2'-1"
2 x 1/4	1.684	1.684	18.3	2'-0"	1'-10"	1'-8"	3'-1"	1'-4"	1'-3"	1'-10"
2 x 5/16	2.105	2.105	22.6	2'-3"	2'-1"	1'-11"	3'-6"	1'-7"	1'-6"	2'-4"
2 x 3/8	2.526	2.526	26.9	2'-6"	2'-4"	2'-2"	3'-10"	1'-10"	1'-9"	2'-9"
2-1/4 x 1/4	2.132	2.398	20.4	2'-3"	2'-1"	1'-11"	3'-9"	1'-7"	1'-6"	2'-4"
2-1/4 x 5/16	2.664	2.998	25.3	2'-7"	2'-5"	2'-3"	4'-2"	1'-11"	1'-10"	2'-11"
2-1/4 x 3/8	3.197	3.597	30.1	2'-10"	2'-8"	2'-7"	4'-5"	2'-2"	2'-2"	3'-5"
2-1/2 x 1/4	2.632	3.289	22.6	2'-6"	2'-4"	2'-3"	4'-4"	1'-10"	1'-10"	2'-10"
2-1/2 x 5/16	3.289	4.112	28.0	2'-11"	2'-9"	2'-7"	4'-8"	2'-3"	2'-3"	3'-6"
2-1/2 x 3/8	3.947	4.934	33.3	3'-4"	3'-2"	3'-0"	4'-11"	2'-7"	2'-7"	4'-2"
3 x 1/4	3.789	5.684	26.9	3'-3"	3'-1"	2'-11"	5'-2"	2'-6"	2'-6"	4'-1"
3 x 5/16	4.737	7.105	33.3	3'-9"	3'-7"	3'-6"	5'-7"	3'-0"	3'-1"	4'-9"
3 x 3/8	5.684	8.526	39.8	4'-4"	4'-2"	4'-1"	5'-11"	3'-7"	3'-8"	5'-1"
3-1/2 x 1/4	5.158	9.026	31.2	4'-0"	3'-10"	3'-9"	6'-0"	3'-3"	3'-4"	5'-2"
3-1/2 x 5/16	6.447	11.283	38.7	4'-9"	4'-8"	4'-7"	6'-6"	4'-0"	4'-1"	5'-7"
3-1/2 x 3/8	7.737	13.539	46.2	5'-0"	5'-0"	5'-0"	6'-11"	4'-8"	4'-10"	5'-11"
4 x 1/4	6.737	13.474	35.5	4'-11"	4'-10"	4'-9"	6'-11"	4'-2"	4'-3"	5'-11"
4 x 5/16	8.421	16.842	44.1	5'-5"	5'-5"	5'-5"	7'-5"	5'-1"	5'-3"	6'-4"
4 x 3/8	10.105	20.211	52.7	5'-8"	5'-8"	5'-9"	7'-11"	5'-6"	5'-8"	6'-9"
4-1/2 x 1/4	8.526	19.184	39.8	5'-7"	5'-7"	5'-8"	7'-9"	5'-1"	5'-4"	6'-8"
4-1/2 x 5/16	10.658	23.980	49.4	6'-0"	6'-0"	6'-1"	8'-4"	5'-10"	6'-0"	7'-2"
4-1/2 x 3/8	12.789	28.776	59.1	6'-5"	6'-5"	6'-5"	8'-11"	6'-2"	6'-4"	7'-7"
5 x 1/4	10.526	26.316	44.1	6'-3"	6'-3"	6'-3"	8'-8"	6'-0"	6'-2"	7'-5"
5 x 3/8	15.789	39.474	65.5	7'-1"	7'-1"	7'-2"	9'-11"	6'-11"	7'-1"	8'-6"
5 x 1/2	21.053	52.632	87.0	7'-10"	7'-10"	7'-11"	10'-11"	7'-7"	7'-9"	9'-4"
6 x 1/4	15.158	45.474	52.7	7'-5"	7'-5"	7'-6"	10'-4"	7'-3"	7'-5"	8'-11"
6 x 3/8	22.737	68.211	78.4	8'-6"	8'-6"	8'-7"	11'-10"	8'-3"	8'-6"	10'-2"
6 x 1/2	30.316	90.947	104.2	9'-4"	9'-4"	9'-5"	13'-1"	9'-1"	9'-4"	11'-2"
7 x 1/4	20.632	72.211	61.2	8'-8"	8'-8"	8'-9"	12'-1"	8'-5"	8'-8"	10'-4"
7 x 3/8	30.947	108.316	91.3	9'-11"	9'-11"	10'-0"	13'-10"	9'-8"	9'-11"	11'-10"
7 x 1/2	41.263	144.421	121.4	10'-10"	10'-11"	11'-0"	15'-3"	10'-7"	10'-11"	13'-1"

# Heavy Duty Grating

## 22 Space (1-3/8") Load Table

Use this table when evaluating spans & loads for the following types of Heavy Duty steel grating:  
**22-W-4 and 22-W-2**



H-25 Load



H-20 Load



H-15 Load



Auto Traffic



5 Ton Forklift



3 Ton Forklift



1 Ton Forklift

Bearing Bar Size (inches)	Section Modulus per foot of width	Moment of Inertia per foot of width	Approx. Weight psf	Maximum Safe Span						
				H-25 Load	H-20 Load	H-15 Load	Auto Traffic	5 Ton Forklift	3 Ton Forklift	1 Ton Forklift
1 x 1/4	0.364	0.182	8.5	0'-11"	0'-10"	0'-9"	0'-11"	0'-7"	0'-6"	0'-6"
1 x 5/16	0.455	0.227	10.4	1'-0"	0'-11"	0'-10"	1'-1"	0'-8"	0'-5"	0'-7"
1 x 3/8	0.545	0.273	12.2	1'-1"	1'-0"	0'-11"	1'-3"	0'-9"	0'-7"	0'-9"
1-1/4 x 1/4	0.568	0.355	10.4	1'-2"	1'-0"	0'-11"	1'-4"	0'-9"	0'-7"	0'-9"
1-1/4 x 5/16	0.710	0.444	12.7	1'-3"	1'-2"	1'-0"	1'-6"	0'-10"	0'-8"	0'-11"
1-1/4 x 3/8	0.852	0.533	15.0	1'-5"	1'-3"	1'-1"	1'-9"	0'-11"	0'-9"	1'-1"
1-1/2 x 1/4	0.818	0.614	12.2	1'-5"	1'-3"	1'-1"	1'-9"	0'-11"	0'-9"	1'-0"
1-1/2 x 5/16	1.023	0.767	15.0	1'-7"	1'-5"	1'-3"	2'-1"	1'-0"	0'-11"	1'-3"
1-1/2 x 3/8	1.227	0.920	17.8	1'-8"	1'-6"	1'-4"	2'-5"	1'-1"	1'-0"	1'-6"
1-3/4 x 1/4	1.114	0.974	14.1	1'-8"	1'-6"	1'-3"	2'-3"	1'-1"	0'-11"	1'-4"
1-3/4 x 5/16	1.392	1.218	17.3	1'-10"	1'-8"	1'-6"	2'-8"	1'-2"	1'-1"	1'-8"
1-3/4 x 3/8	1.670	1.462	20.6	2'-0"	1'-10"	1'-8"	3'-0"	1'-4"	1'-3"	1'-11"
2 x 1/4	1.455	1.455	16.0	1'-10"	1'-8"	1'-6"	2'-10"	1'-3"	1'-2"	1'-9"
2 x 5/16	1.818	1.818	19.7	2'-1"	1'-11"	1'-9"	3'-4"	1'-5"	1'-5"	2'-1"
2 x 3/8	2.182	2.182	23.4	2'-4"	2'-1"	2'-0"	3'-8"	1'-8"	1'-7"	2'-6"
2-1/4 x 1/4	1.841	2.071	17.8	2'-1"	1'-11"	1'-9"	3'-5"	1'-6"	1'-5"	2'-2"
2-1/4 x 5/16	2.301	2.589	22.0	2'-4"	2'-2"	2'-0"	4'-0"	1'-9"	1'-8"	2'-8"
2-1/4 x 3/8	2.761	3.107	26.2	2'-8"	2'-6"	2'-4"	4'-3"	2'-0"	2'-0"	3'-2"
2-1/2 x 1/4	2.273	2.841	19.7	2'-4"	2'-2"	2'-0"	4'-2"	1'-8"	1'-8"	2'-7"
2-1/2 x 5/16	2.841	3.551	24.3	2'-8"	2'-6"	2'-5"	4'-6"	2'-0"	2'-0"	3'-3"
2-1/2 x 3/8	3.409	4.261	28.9	3'-0"	2'-10"	2'-9"	4'-9"	2'-4"	2'-4"	3'-10"
3 x 1/4	3.273	4.909	23.4	2'-11"	2'-9"	2'-8"	5'-0"	2'-3"	2'-3"	3'-8"
3 x 5/16	4.091	6.136	28.9	3'-5"	3'-3"	3'-2"	5'-4"	2'-9"	2'-9"	4'-7"
3 x 3/8	4.909	7.364	34.5	3'-11"	3'-9"	3'-8"	5'-8"	3'-2"	3'-4"	4'-11"
3-1/2 x 1/4	4.455	7.795	27.1	3'-8"	3'-6"	3'-5"	5'-10"	2'-11"	3'-0"	5'-0"
3-1/2 x 5/16	5.568	9.744	33.6	4'-4"	4'-2"	4'-1"	6'-3"	3'-7"	3'-8"	5'-5"
3-1/2 x 3/8	6.682	11.693	40.1	4'-10"	4'-10"	4'-10"	6'-8"	4'-2"	4'-5"	5'-9"
4 x 1/4	5.818	11.636	30.8	4'-5"	4'-4"	4'-3"	6'-8"	3'-9"	3'-10"	5'-9"
4 x 5/16	7.273	14.545	38.2	5'-2"	5'-2"	5'-2"	7'-2"	4'-6"	4'-9"	6'-2"
4 x 3/8	8.727	17.455	45.6	5'-6"	5'-6"	5'-6"	7'-7"	5'-3"	5'-5"	6'-7"
4-1/2 x 1/4	7.364	16.568	34.5	5'-4"	5'-3"	5'-3"	7'-6"	4'-7"	4'-10"	6'-5"
4-1/2 x 5/16	9.205	20.710	42.8	5'-9"	5'-9"	5'-10"	8'-1"	5'-7"	5'-9"	6'-11"
4-1/2 x 3/8	11.045	24.852	51.2	6'-2"	6'-2"	6'-2"	8'-7"	5'-11"	6'-1"	7'-5"
5 x 1/4	9.091	22.727	38.2	5'-11"	6'-0"	6'-0"	8'-4"	5'-7"	5'-11"	7'-2"
5 x 3/8	13.636	34.091	56.8	6'-9"	6'-10"	6'-10"	9'-6"	6'-7"	6'-10"	8'-3"
5 x 1/2	18.182	45.455	75.3	7'-6"	7'-6"	7'-7"	10'-6"	7'-3"	7'-6"	9'-1"
6 x 1/4	13.091	39.273	45.6	7'-1"	7'-2"	7'-2"	10'-0"	6'-11"	7'-2"	8'-7"
6 x 3/8	19.636	58.909	67.9	8'-1"	8'-2"	8'-3"	11'-5"	7'-11"	8'-2"	9'-10"
6 x 1/2	26.182	78.545	90.1	8'-11"	9'-0"	9'-1"	12'-7"	8'-9"	9'-0"	10'-10"
7 x 1/4	17.818	62.364	53.1	8'-3"	8'-4"	8'-5"	11'-8"	8'-1"	8'-4"	10'-1"
7 x 3/8	26.727	93.545	79.0	9'-5"	9'-6"	9'-7"	13'-4"	9'-3"	9'-6"	11'-6"
7 x 1/2	35.636	124.727	105.0	10'-5"	10'-6"	10'-7"	14'-8"	10'-2"	10'-6"	12'-8"

# Heavy Duty Grating

## 30 Space (1-7/8") Load Table

Use this table when evaluating spans & loads for the following types of Heavy Duty steel grating:  
**30-W-4 and 30-W-2**



Bearing Bar Size (inches)	Section Modulus per foot of width	Moment of Inertia per foot of width	Approx. Weight psf	Maximum Safe Span						
				H-25 Load	H-20 Load	H-15 Load	Auto Traffic	5 Ton Forklift	3 Ton Forklift	1 Ton Forklift
1 x 1/4	0.267	0.133	6.6	0'-9"	0'-9"	0'-8"	0'-10"	0'-6"	0'-5"	0'-6"
1 x 5/16	0.333	0.167	7.9	0'-11"	0'-10"	0'-8"	0'-11"	0'-7"	0'-6"	0'-7"
1 x 3/8	0.400	0.200	9.3	1'-0"	0'-11"	0'-9"	1'-1"	0'-8"	0'-6"	0'-8"
1-1/4 x 1/4	0.417	0.260	7.9	1'-0"	0'-11"	0'-10"	1'-1"	0'-8"	0'-6"	0'-8"
1-1/4 x 5/16	0.521	0.326	9.6	1'-1"	1'-0"	0'-11"	1'-3"	0'-9"	0'-7"	0'-9"
1-1/4 x 3/8	0.625	0.391	11.3	1'-3"	1'-1"	1'-0"	1'-6"	0'-10"	0'-8"	0'-11"
1-1/2 x 1/4	0.600	0.450	9.3	1'-2"	1'-1"	1'-0"	1'-5"	0'-9"	0'-8"	0'-11"
1-1/2 x 5/16	0.750	0.563	11.3	1'-4"	1'-3"	1'-1"	1'-9"	0'-10"	0'-9"	1'-1"
1-1/2 x 3/8	0.900	0.675	13.4	1'-6"	1'-4"	1'-2"	2'-0"	1'-0"	0'-10"	1'-3"
1-3/4 x 1/4	0.817	0.715	10.6	1'-5"	1'-3"	1'-2"	1'-10"	0'-11"	0'-10"	1'-2"
1-3/4 x 5/16	1.021	0.893	13.0	1'-7"	1'-5"	1'-3"	2'-2"	1'-0"	0'-11"	1'-5"
1-3/4 x 3/8	1.225	1.072	15.4	1'-9"	1'-7"	1'-5"	2'-7"	1'-2"	1'-1"	1'-8"
2 x 1/4	1.067	1.067	12.0	1'-7"	1'-6"	1'-4"	2'-3"	1'-1"	1'-0"	1'-6"
2 x 5/16	1.333	1.333	14.7	1'-10"	1'-8"	1'-6"	2'-9"	1'-3"	1'-2"	1'-10"
2 x 3/8	1.600	1.600	17.4	2'-0"	1'-10"	1'-8"	3'-3"	1'-5"	1'-4"	2'-2"
2-1/4 x 1/4	1.350	1.519	13.4	1'-10"	1'-8"	1'-6"	2'-10"	1'-3"	1'-2"	1'-10"
2-1/4 x 5/16	1.688	1.898	16.4	2'-0"	1'-10"	1'-9"	3'-5"	1'-5"	1'-5"	2'-3"
2-1/4 x 3/8	2.025	2.278	19.5	2'-3"	2'-1"	1'-11"	3'-11"	1'-8"	1'-8"	2'-8"
2-1/2 x 1/4	1.667	2.083	14.7	2'-0"	1'-10"	1'-8"	3'-5"	1'-5"	1'-5"	2'-3"
2-1/2 x 5/16	2.083	2.604	18.1	2'-3"	2'-1"	2'-0"	4'-2"	1'-8"	1'-8"	2'-9"
2-1/2 x 3/8	2.500	3.125	21.5	2'-6"	2'-5"	2'-3"	4'-5"	1'-11"	2'-0"	3'-3"
3 x 1/4	2.400	3.600	17.4	2'-6"	2'-4"	2'-2"	4'-7"	1'-11"	1'-11"	3'-2"
3 x 5/16	3.000	4.500	21.5	2'-10"	2'-8"	2'-7"	5'-0"	2'-3"	2'-4"	3'-11"
3 x 3/8	3.600	5.400	25.6	3'-3"	3'-1"	3'-0"	5'-3"	2'-7"	2'-9"	4'-8"
3-1/2 x 1/4	3.267	5.717	20.2	3'-0"	2'-10"	2'-9"	5'-5"	2'-5"	2'-6"	4'-3"
3-1/2 x 5/16	4.083	7.146	24.9	3'-6"	3'-5"	3'-4"	5'-10"	2'-11"	3'-1"	5'-1"
3-1/2 x 3/8	4.900	8.575	29.7	4'-0"	3'-11"	3'-10"	6'-2"	3'-5"	3'-7"	5'-5"
4 x 1/4	4.267	8.533	22.9	3'-7"	3'-6"	3'-7"	6'-2"	3'-0"	3'-2"	5'-5"
4 x 5/16	5.333	10.667	28.3	4'-1"	4'-2"	4'-2"	6'-8"	3'-8"	3'-11"	5'-10"
4 x 3/8	6.400	12.800	33.8	4'-11"	4'-10"	4'-10"	7'-1"	4'-4"	4'-8"	6'-2"
4-1/2 x 1/4	5.400	12.150	25.6	4'-4"	4'-3"	4'-2"	6'-11"	3'-8"	3'-11"	6'-1"
4-1/2 x 5/16	6.750	15.188	31.7	5'-2"	5'-1"	5'-1"	7'-6"	4'-6"	4'-10"	6'-7"
4-1/2 x 3/8	8.100	18.225	37.8	5'-7"	5'-7"	5'-8"	7'-11"	5'-4"	5'-8"	7'-0"
5 x 1/4	6.667	16.667	28.3	5'-1"	5'-0"	5'-0"	7'-8"	4'-6"	4'-10"	6'-9"
5 x 3/8	10.000	25.000	41.9	6'-3"	6'-3"	6'-4"	8'-10"	6'-1"	6'-4"	7'-9"
5 x 1/2	13.333	33.333	55.5	6'-10"	6'-10"	6'-11"	9'-8"	6'-9"	7'-0"	8'-7"
6 x 1/4	9.600	28.800	33.8	6'-6"	6'-6"	6'-7"	9'-3"	6'-3"	6'-8"	8'-2"
6 x 3/8	14.400	43.200	50.1	7'-5"	7'-6"	7'-7"	10'-7"	7'-4"	7'-7"	9'-4"
6 x 1/2	19.200	57.600	66.4	8'-2"	8'-3"	8'-4"	11'-8"	8'-1"	8'-5"	10'-3"
7 x 1/4	13.067	45.733	39.2	7'-7"	7'-7"	7'-9"	10'-9"	7'-6"	7'-9"	9'-6"
7 x 3/8	19.600	68.600	58.2	8'-8"	8'-8"	8'-10"	12'-4"	8'-7"	8'-11"	10'-11"
7 x 1/2	26.133	91.467	77.3	9'-6"	9'-7"	9'-9"	13'-7"	9'-5"	9'-9"	12'-0"

# Heavy Duty Grating

## 38 Space (2-3/8") Load Table

Use this table when evaluating spans & loads for the following types of Heavy Duty steel grating:  
**38-W-4 and 38-W-2**



H-25 Load



H-20 Load



H-15 Load



Auto Traffic



5 Ton Forklift



3 Ton Forklift



1 Ton Forklift

Bearing Bar Size (inches)	Section Modulus per foot of width	Moment of Inertia per foot of width	Approx. Weight psf	Maximum Safe Span						
				H-25 Load	H-20 Load	H-15 Load	Auto Traffic	5 Ton Forklift	3 Ton Forklift	1 Ton Forklift
1 x 1/4	0.211	0.105	5.4	0'-8"	0'-8"	0'-7"	0'-9"	0'-6"	0'-5"	0'-5"
1 x 5/16	0.263	0.132	6.5	0'-10"	0'-9"	0'-8"	0'-10"	0'-6"	0'-5"	0'-6"
1 x 3/8	0.316	0.158	7.6	0'-10"	0'-10"	0'-8"	0'-11"	0'-7"	0'-6"	0'-7"
1-1/4 x 1/4	0.329	0.206	6.5	0'-11"	0'-10"	0'-9"	1'-0"	0'-8"	0'-6"	0'-7"
1-1/4 x 5/16	0.411	0.257	7.8	1'-0"	0'-11"	0'-10"	1'-2"	0'-8"	0'-7"	0'-9"
1-1/4 x 3/8	0.493	0.308	9.2	1'-1"	1'-0"	0'-11"	1'-4"	0'-9"	0'-7"	0'-10"
1-1/2 x 1/4	0.474	0.355	7.6	1'-1"	1'-0"	0'-10"	1'-3"	0'-9"	0'-7"	0'-10"
1-1/2 x 5/16	0.592	0.444	9.2	1'-3"	1'-1"	1'-0"	1'-6"	0'-10"	0'-8"	1'-0"
1-1/2 x 3/8	0.711	0.533	10.8	1'-4"	1'-3"	1'-1"	1'-9"	0'-11"	0'-9"	1'-2"
1-3/4 x 1/4	0.645	0.564	8.6	1'-4"	1'-2"	1'-0"	1'-7"	0'-10"	0'-9"	1'-0"
1-3/4 x 5/16	0.806	0.705	10.5	1'-5"	1'-3"	1'-2"	1'-11"	0'-11"	0'-10"	1'-3"
1-3/4 x 3/8	0.967	0.846	12.4	1'-7"	1'-5"	1'-3"	2'-3"	1'-1"	1'-0"	1'-6"
2 x 1/4	0.842	0.842	9.7	1'-5"	1'-4"	1'-2"	2'-0"	1'-0"	0'-11"	1'-4"
2 x 5/16	1.053	1.053	11.9	1'-8"	1'-6"	1'-4"	2'-5"	1'-1"	1'-0"	1'-7"
2 x 3/8	1.263	1.263	14.0	1'-9"	1'-8"	1'-6"	2'-10"	1'-3"	1'-2"	1'-11"
2-1/4 x 1/4	1.066	1.199	10.8	1'-8"	1'-6"	1'-4"	2'-5"	1'-1"	1'-1"	1'-8"
2-1/4 x 5/16	1.332	1.499	13.2	1'-10"	1'-8"	1'-6"	3'-0"	1'-3"	1'-3"	2'-0"
2-1/4 x 3/8	1.599	1.799	15.6	2'-0"	1'-10"	1'-8"	3'-6"	1'-5"	1'-5"	2'-5"
2-1/2 x 1/4	1.316	1.645	11.9	1'-10"	1'-8"	1'-6"	2'-11"	1'-3"	1'-3"	2'-0"
2-1/2 x 5/16	1.645	2.056	14.5	2'-1"	1'-11"	1'-9"	3'-7"	1'-6"	1'-6"	2'-6"
2-1/2 x 3/8	1.974	2.467	17.2	2'-3"	2'-1"	2'-0"	4'-2"	1'-8"	1'-9"	2'-11"
3 x 1/4	1.895	2.842	14.0	2'-2"	2'-1"	1'-11"	4'-1"	1'-8"	1'-8"	2'-10"
3 x 5/16	2.368	3.553	17.2	2'-6"	2'-4"	2'-3"	4'-9"	1'-11"	2'-0"	3'-6"
3 x 3/8	2.842	4.263	20.4	2'-10"	2'-8"	2'-7"	5'-0"	2'-3"	2'-5"	4'-2"
3-1/2 x 1/4	2.579	4.513	16.2	2'-8"	2'-6"	2'-5"	5'-1"	2'-1"	2'-2"	3'-9"
3-1/2 x 5/16	3.224	5.641	19.9	3'-1"	2'-11"	2'-10"	5'-6"	2'-6"	2'-8"	4'-8"
3-1/2 x 3/8	3.868	6.770	23.7	3'-6"	3'-4"	3'-4"	5'-10"	2'-11"	3'-2"	5'-3"
4 x 1/4	3.368	6.737	18.3	3'-2"	3'-0"	2'-11"	5'-10"	2'-7"	2'-9"	4'-11"
4 x 5/16	4.211	8.421	22.6	3'-8"	3'-7"	3'-7"	6'-3"	3'-2"	3'-5"	5'-7"
4 x 3/8	5.053	10.105	26.9	4'-3"	4'-2"	4'-2"	6'-8"	3'-8"	4'-0"	6'-0"
4-1/2 x 1/4	4.263	9.592	20.4	3'-9"	3'-7"	3'-7"	6'-7"	3'-2"	3'-5"	5'-10"
4-1/2 x 5/16	5.329	11.990	25.3	4'-5"	4'-4"	4'-4"	7'-1"	3'-11"	4'-3"	6'-4"
4-1/2 x 3/8	6.395	14.388	30.1	5'-1"	5'-0"	5'-1"	7'-6"	4'-7"	5'-0"	6'-9"
5 x 1/4	5.263	13.158	22.6	4'-4"	4'-3"	4'-3"	7'-4"	3'-10"	4'-2"	6'-6"
5 x 3/8	7.895	19.737	33.3	5'-10"	5'-10"	5'-11"	8'-4"	5'-6"	6'-0"	7'-6"
5 x 1/2	10.526	26.316	44.1	6'-5"	6'-5"	6'-6"	9'-2"	6'-4"	6'-8"	8'-3"
6 x 1/4	7.579	22.737	26.9	5'-10"	5'-10"	5'-11"	8'-9"	5'-4"	5'-11"	7'-10"
6 x 3/8	11.368	34.105	39.8	6'-11"	7'-0"	7'-1"	10'-0"	6'-11"	7'-3"	9'-0"
6 x 1/2	15.158	45.474	52.7	7'-8"	7'-8"	7'-10"	11'-1"	7'-7"	8'-0"	9'-11"
7 x 1/4	10.316	36.105	31.2	7'-1"	7'-2"	7'-3"	10'-3"	7'-1"	7'-5"	9'-2"
7 x 3/8	15.474	54.158	46.2	8'-1"	8'-2"	8'-4"	11'-8"	8'-1"	8'-5"	10'-6"
7 x 1/2	20.632	72.211	61.2	8'-11"	9'-0"	9'-2"	12'-11"	8'-11"	9'-4"	11'-6"

**Bridge Decking** is manufactured by cold-press riveting truss shaped reticuline bars to parallel rectangular bearing bars. The resulting product is an exceptionally durable heavy duty grating with superior stiffness and lateral stability. Bridge Decking is often the preferred heavy duty grating for concentrated or stress applications subject to impact and repetitive loads. Popular applications include bridge floors, highway inlets, and airport trench drain covers.

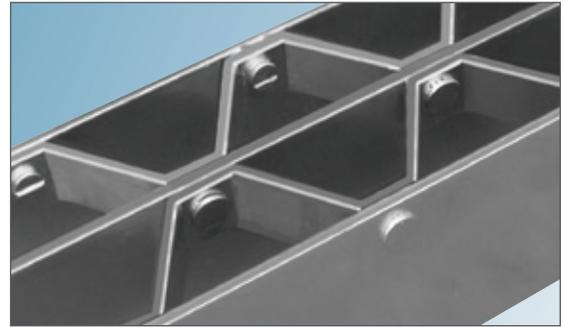
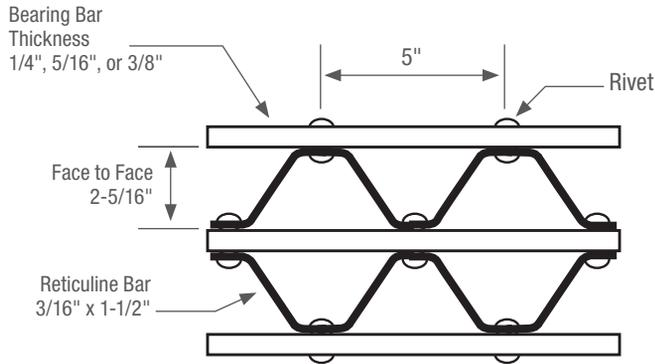

**37-R-5  
Plain  
Surface**

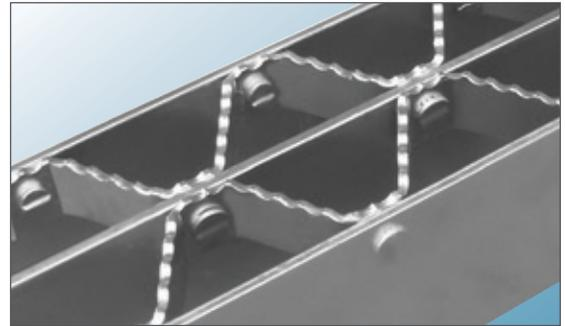

**37-R-5  
Serrated  
Surface**

## Load Table: Type 37-R-5 Bridge Decking



Bearing Bar Size	Reticuline Bar Size	Section Modulus per foot of width	Moment of Inertia per foot of width	Approx. Weight psf	Maximum Safe Span						
					H-25 Load	H-20 Load	H-15 Load	Auto Traffic	5 Ton Forklift	3 Ton Forklift	1 Ton Forklift
2-1/2" x 1/4"	1-1/2" x 3/16"	1.422	1.999	17.0	1'-11"	1'-9"	1'-7"	3'-2"	1'-4"	1'-4"	2'-2"
2-1/2" x 5/16"	1-1/2" x 3/16"	1.691	2.338	19.0	2'-1"	1'-11"	1'-9"	3'-4"	1'-6"	1'-6"	2'-7"
2-1/2" x 3/8"	1-1/2" x 3/16"	1.946	2.657	20.8	2'-3"	2'-1"	2'-0"	4'-3"	1'-9"	1'-9"	3'-0"
3" x 1/4"	1-1/2" x 3/16"	2.006	3.42	19.3	2'-3"	2'-1"	2'-0"	4'-4"	1'-9"	1'-9"	3'-0"
3" x 5/16"	1-1/2" x 3/16"	2.398	4.012	21.8	2'-6"	2'-6"	2'-4"	5'-2"	2'-0"	2'-1"	3'-8"
3" x 3/8"	1-1/2" x 3/16"	2.769	4.568	24.0	2'-9"	2'-8"	2'-7"	6'-0"	2'-3"	2'-5"	4'-3"
3-1/2" x 1/4"	1-1/2" x 3/16"	2.723	5.427	21.5	2'-9"	2'-7"	2'-6"	5'-9"	2'-2"	2'-4"	4'-0"
3-1/2" x 5/16"	1-1/2" x 3/16"	3.258	6.368	23.3	3'-1"	3'-0"	2'-11"	6'-11"	2'-7"	2'-9"	4'-11"
3-1/2" x 3/8"	1-1/2" x 3/16"	3.764	7.252	27.1	3'-5"	3'-4"	3'-3"	8'-0"	2'-11"	3'-2"	5'-9"
4" x 1/4"	1-1/2" x 3/16"	3.560	8.097	23.8	3'-3"	3'-2"	3'-1"	7'-5"	2'-9"	2'-11"	5'-3"
4" x 5/16"	1-1/2" x 3/16"	4.261	9.500	27.2	3'-9"	3'-8"	3'-7"	8'-0"	3'-3"	3'-6"	6'-4"
4" x 3/8"	1-1/2" x 3/16"	4.923	10.818	30.2	4'-2"	4'-1"	4'-1"	8'-0"	3'-8"	4'-1"	7'-5"
4-1/2" x 1/4"	1-1/2" x 3/16"	4.513	11.508	26.0	3'-11"	3'-10"	3'-10"	6'-11"	3'-5"	3'-8"	6'-2"
4-1/2" x 5/16"	1-1/2" x 3/16"	5.400	13.500	29.7	4'-6"	4'-5"	4'-6"	7'-4"	4'-0"	4'-5"	6'-5"
4-1/2" x 3/8"	1-1/2" x 3/16"	6.238	15.372	33.3	5'-0"	5'-0"	5'-1"	7'-9"	4'-7"	5'-1"	6'-11"
5" x 1/4"	1-1/2" x 3/16"	5.577	15.735	28.3	4'-7"	4'-6"	4'-6"	8'-0"	4'-1"	4'-6"	8'-0"
5" x 5/16"	1-1/2" x 3/16"	6.671	18.459	32.6	5'-3"	5'-3"	5'-4"	8'-0"	4'-10"	5'-4"	8'-0"
5" x 3/8"	1-1/2" x 3/16"	7.705	21.021	36.5	6'-0"	6'-0"	6'-1"	8'-0"	5'-7"	6'-3"	8'-0"

Loads are theoretical and based upon 20,000 psi unit stress. Load criteria and distribution is in accordance with the table of Maximum Traffic Conditions found on page 37 of this catalog. Section properties were developed using the Parallel Axis Theorem for determining centroid and "I" values.

## 37-R-5 Panel Width Chart

Dimensions are out-to-out of bearing bars\*

Number of Bearing Bars	2	3	4	5	6	7	8	9	10	11	12	13	14	15	16
<b>1/4" Thick Bars</b>	2-13/16"	5-3/8"	7-15/16"	10-1/2"	13-1/16"	15-5/8"	18-3/16"	20-3/4"	23-5/16"	25-7/8"	28-7/16"	31"	33-9/16"	36-1/8"	38-11/16"
<b>5/16" Thick Bars</b>	2-15/16"	5-9/16"	8-3/16"	10-13/16"	13-7/16"	16-1/16"	18-11/16"	21-5/16"	23-15/16"	26-9/16"	29-3/16"	31-13/16"	34-7/16"	37-1/16"	39-11/16"
<b>3/8" Thick Bars</b>	3-1/16"	5-3/4"	8-7/16"	11-1/8"	13-13/16"	16-1/2"	19-3/16"	21-7/8"	24-9/16"	27-1/4"	29-15/16"	32-5/8"	35-5/16"	38"	40-11/16"

\* Add 3/8" for rivet heads protruding outside of bearing bars

# Embed Frames

**Embed frames** cast into concrete floors and substructures serve a multitude of purposes that extend the effective life of your completed construction project. Frames form a rigid shield for concrete lead edges and perimeters which are subject to cracking and chipping when left unprotected.

During construction, these rigid (1/4" minimum thickness) frames expedite forming and provide a welded structure that assures accuracy in the concrete pour. Frames provide a uniform bearing surface for the grates or covers, often eliminating rocking or irregular elevations experienced with grates or covers installed directly on poured concrete.

When you specify Grating Pacific embed frames you are specifying durability, accuracy, and economy.

Nail holes are optional and may further expedite installation. If desired, size and location of nail holes shall be indicated.

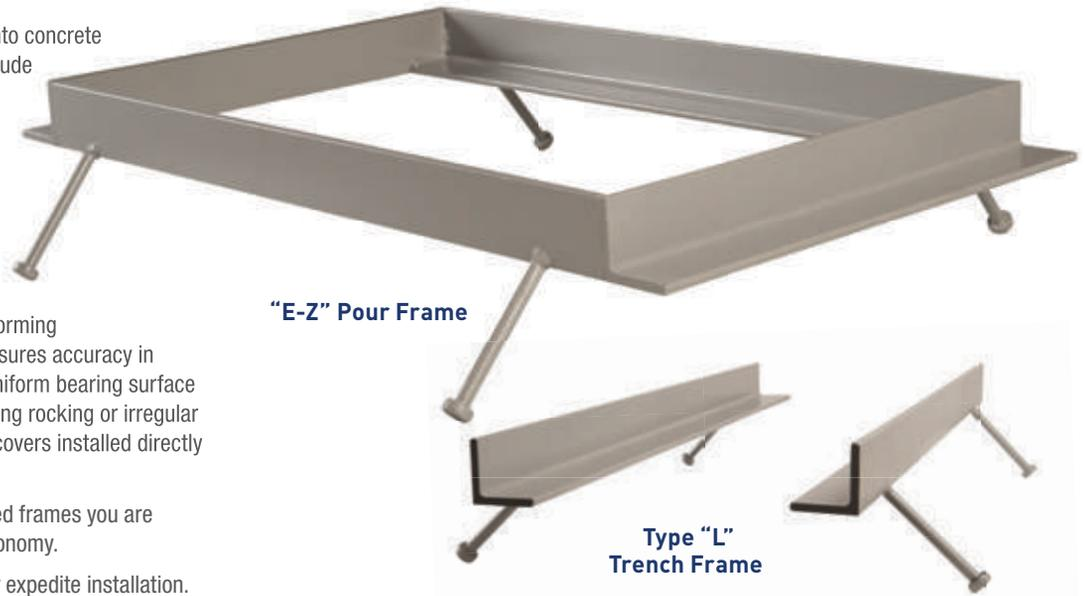

## E-Z Pour Frames

Grating Pacific **E-Z Pour** frames are designed to expedite the forming process and provide superior concrete embedment. Assembled with continuous anchors on the non-bearing sides, **E-Z Pour** frames install quickly and provide superior drainage.

## Welded Frames

All frames are available in four sided, one piece, welded construction units that can accommodate any clear opening. Frame sections shown below illustrate the various configurations for edge protection. Simply specify the frame type, desired clear opening ("W" and "S" dimensions), and desired grating or cover thickness.

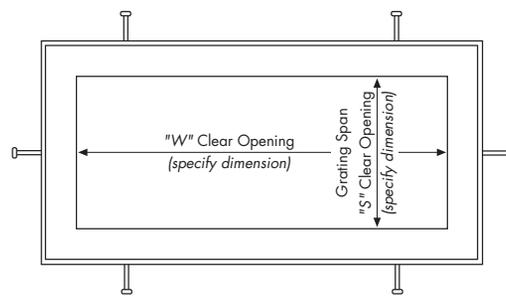
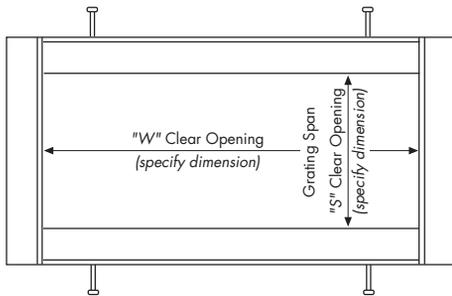

## Frame Sections

Dimensions indicated in table (page 45)

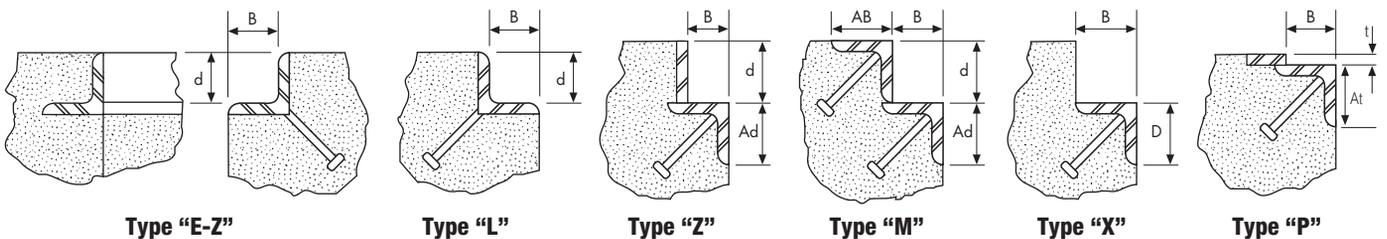

## Anchors

All frames are provided with 3/8" x 4" headed concrete stud anchors welded within 6" of each end and at a maximum of 24" on center. Alternative anchor sizes and spacings may be designated by the specifying authority.

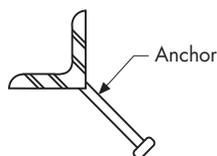

## Materials & Finishes

Carbon steel frames are manufactured with one of three standard finishes, bare steel (no finish), painted, or hot dip galvanized after fabrication. Aluminum frames are provided mill finish and can be specified with bituminous coating on surfaces to be cast in concrete. Stainless steel frames are supplied mill finish and can be specified as abrasive blasted after fabrication to provide a uniform matte finish.

## Frame Specifications

The following table indicates fabrication dimensions for steel embed frames presented on page 44. Embed frames manufactured from stainless steel or aluminum are similarly available, but will vary dimensionally. Consult Grating Pacific for dimensions if critical.

Model Number	"d"	"B"	Model Number	"d"	"B"	Model Number	"d"	"B"	"Ad"	Model Number	"d"	"B"	"AB"	"Ad"
EZ-75	3/4"	3/4"	L-75	3/4"	3/4"	Z-75	3/4"	1"	1-1/2"	M-75	3/4"	1-1/2"	3/4"	2"
EZ-100	1"	1"	L-100	1"	1"	Z-100	1"	1-1/4"	1-3/4"	M-100	1"	1-1/2"	1"	2"
EZ-125	1-1/4"	1-1/4"	L-125	1-1/4"	1-1/4"	Z-125	1-1/4"	1-1/2"	2"	M-125	1-1/4"	1-1/2"	1-1/4"	2"
EZ-150	1-1/2"	1-1/2"	L-150	1-1/2"	1-1/2"	Z-150	1-1/2"	1-1/2"	2"	M-150	1-1/2"	1-1/2"	1-1/2"	2"
EZ-175	1-3/4"	1-3/4"	L-175	1-3/4"	1-3/4"	Z-175	1-3/4"	2"	2-1/2"	M-175	1-3/4"	2"	1-3/4"	2"
EZ-200	2"	2-1/4"	L-200	2"	2-1/4"	Z-200	2"	2"	2-1/2"	M-200	2"	2"	2"	2"
EZ-225	2-1/4"	2-1/4"	L-225	2-1/4"	2-1/4"	Z-225	2-1/4"	2"	2-1/2"	M-225	2-1/4"	2"	2"	2"
EZ-250	2-1/2"	2-1/4"	L-250	2-1/2"	2-1/4"	Z-250	2-1/2"	2-1/2"	3"	M-250	2-1/2"	2"	2"	2"
EZ-300	3"	2-3/4"	L-300	3"	2-3/4"	Z-300	3"	2-1/2"	3"	M-300	3"	2"	2"	2"
EZ-350	3-1/2"	2-3/4"	L-350	3-1/2"	2-3/4"	Z-350	3-1/2"	2-1/2"	3"	M-350	3-1/2"	3"	2-1/2"	2-1/2"
EZ-400	4"	2-3/4"	L-400	4"	2-3/4"	Z-400	4"	3"	3-1/2"	M-400	4"	3"	3"	2-1/2"
EZ-500	5"	3-1/4"	L-500	5"	3-1/4"	Z-500	5"	3"	3-1/2"	M-500	5"	3-1/2"	3"	3"
EZ-600	6"	3-1/4"	L-600	6"	3-1/4"	Z-600	6"	3"	3-1/2"	M-600	6"	3-1/2"	3-1/2"	3"

Model Number	"B"	"D"	Model Number	"B"	"D"	Model Number	"B"	"D"		Model Number	"t"	"B"	"At"	
X-100	1"	1"	X-400	4"	4"	X-3530	3-1/2"	3"	—	P-125	1/8"	1-1/2"	2"	—
X-125	1-1/4"	1-1/4"	X-500	5"	5"	X-4030	4"	3"	—	P-188	3/16"	1-1/2"	2"	—
X-150	1-1/2"	1-1/2"	X-600	6"	6"	X-5030	5"	3"	—	P-250	1/4"	1-1/2"	2"	—
X-175	1-3/4"	1-3/4"	X-2515	2-1/2"	1-1/2"	X-5035	5"	3-1/2"	—	P-313	5/16"	1-1/2"	2"	—
X-200	2"	2"	X-2520	2-1/2"	2"	X-6035	6"	3-1/2"	—	P-375	3/8"	1-1/2"	2"	—
X-250	2-1/2"	2-1/2"	X-3020	3"	2"	X-6040	6"	4"	—	P-500	1/2"	1-1/2"	2"	—
X-300	3"	3"	X-3025	3"	2-1/2"		—	—	—	P-625	5/8"	2"	2-1/2"	—
X-350	3-1/2"	3-1/2"	X-3525	3-1/2"	2-1/2"		—	—	—	P-750	3/4"	2"	2-1/2"	—
							—	—	—	P-1000	1"	2"	2-1/2"	—

## Trench & Inlet Systems

The combination of Grating Pacific gratings and embed frames provides the specifier with a wide range of alternatives for drainage applications. While any of the bar grating products and embed frames shown on the previous pages can be combined for effective solutions, the trench systems and inlet sets illustrated on pages 46-49 are the most economical solution to drainage requirements.



## Custom Sets

If the standard sets described on pages 46-49 do not adequately address your specific application in either load capacity or appearance, please contact our engineering department. We will gladly assist in the selection of an appropriate alternative from our wide range of versatile products.

# Trench & Inlet Systems

Grating Pacific Trench and Inlet Systems combine our most popular gratings and embed frames to provide economic, modular components for construction projects. These products are offered in Standard Duty, designed to serve pedestrian loads, and Heavy Duty, designed to service the most demanding vehicular traffic. Each series is offered with multiple bar spacings (shown below) to address the specific needs of your application.

## Standard Duty



### Type "S"

Designed to support pedestrian loads, type "S" gratings are manufactured from welded grating with durable 3/16" (min.) thick bearing bars. Open area of nearly 80% allows for fast clearing of moisture and run-off.



### Type "SA"

Standard Duty type "SA" gratings are designed to conform with strict ADA spacing requirements. Open area of 68% allows for drainage and ventilation while maintaining a safe traffic surface.



### Type "SP"

Type "SP" gratings also comply with ADA spacing requirements. Additionally, the 1/4" maximum clear opening between the bearing bars make these gratings desirable in areas subject to pedestrian traffic where high heeled shoes are common.



## Heavy Duty



### Type "H"

Type "H" gratings are manufactured from stout, 3/8" (min.) thick bearing bars. Designed to serve the most rigorous truck and forklift loads. With nearly 70% open area, these products are ideal for parking lot and highway drain applications.



### Type "HA"

Heavy duty type "HA" gratings are similar to type "SA" above with the exception that these gratings are additionally designed to support forklift and vehicular loads.



### Type "HP"

Heavy duty type "HP" gratings are similar to type "SP" above with the exception that these gratings are additionally designed to support forklift and vehicular loads.



## Bolted Grates

Grating Pacific Trench and Inlet Systems are manufactured as component products with the gratings easily removed for clearing debris from the trenches or inlets. Often, security concerns or traffic conditions dictate that the gratings must be bolted to the framing. When this option is specified, weld lugs or countersunk lands are installed on the gratings and the bolt is installed below the traffic surface of the grating. For high security applications, bolted gratings with tamper-resistant fasteners may be further specified. Examples are shown below.



**Bolted Grates  
w/ Weld Lug**



**Tamper-Resistant Bolt  
w/ Weld Lug**



**Close Mesh Bolting  
w/ Counter Sunk Land**

# Trench Grating Systems

Trench Grating Systems by Grating Pacific allow the specifier to combine any of the gratings illustrated on the preceding page with any of the embed frames profiled on page 44. Systems are available in Standard Duty for pedestrian loads or Heavy Duty for vehicular traffic. Unlike cast iron or molded trench products, this flexible system allows the user to specify the exact clear opening ("S" dimension) desired. Because Grating Pacific offers five distinct embed frame profiles, the user can select a frame to meet the exact edge condition desired. Bolting the gratings to the frames is optional and must be specified.

All gratings are provided with plain surface (the optional serrated surface is available when specified) and open ends are trench banded to maximize drain capacity.

Unless otherwise noted, all trench frames and grating are hot dip galvanized after fabrication in accordance with ASTM Specification A-123. Our most popular systems are listed in the table below.

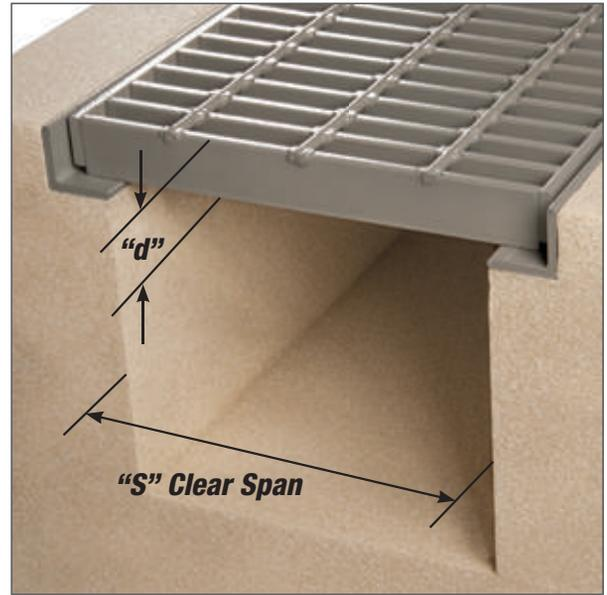

## How to Specify Trench Systems

Trench systems are specified by component model numbers. Simply follow the sample specification below.

**TH - 12 - EZ (B)**

"T" indicates trench grating while "H" indicates type H Heavy Duty grating as shown on page 46. Specify Heavy Duty (type H, HA, or HP), or Standard Duty (type S, SA, or SP).

Indicates trench clear span or "S" dimension in inches.

Indicates type of frame from sections illustrated on page 44.

Optional component to specify bolted grates. If bolted grates are not required, this suffix is omitted.

## Standard Trench Systems

### Standard Duty



### Heavy Duty



Standard Duty									Heavy Duty								
Model Number	"S"	"d"	Model Number	"S"	"d"	Model Number	"S"	"d"	Model Number	"S"	"d"	Model Number	"S"	"d"	Model Number	"d"	"d"
TS-6-EZ	6"	1"	TSA-6-EZ	6"	1"	TSP-6-EZ	6"	1"	TH-6-EZ	6"	1-1/2"	THA-6-EZ	6"	1-1/2"	THP-6-EZ	6"	1-1/2"
TS-8-EZ	8"	1"	TSA-8-EZ	8"	1"	TSP-8-EZ	8"	1"	TH-8-EZ	8"	1-1/2"	THA-8-EZ	8"	1-1/2"	THP-8-EZ	8"	1-1/2"
TS-10-EZ	10"	1"	TSA-10-EZ	10"	1"	TSP-10-EZ	10"	1"	TH-10-EZ	10"	1-1/2"	THA-10-EZ	10"	1-1/2"	THP-10-EZ	10"	1-1/2"
TS-12-EZ	12"	1"	TSA-12-EZ	12"	1"	TSP-12-EZ	12"	1"	TH-12-EZ	12"	1-1/2"	THA-12-EZ	12"	1-3/4"	THP-12-EZ	12"	1-1/2"
TS-14-EZ	14"	1"	TSA-14-EZ	14"	1"	TSP-14-EZ	14"	1"	TH-14-EZ	14"	1-3/4"	THA-14-EZ	14"	2-1/4"	THP-14-EZ	14"	1-3/4"
TS-16-EZ	16"	1"	TSA-16-EZ	16"	1"	TSP-16-EZ	16"	1"	TH-16-EZ	16"	2-1/4"	THA-16-EZ	16"	2-1/4"	THP-16-EZ	16"	1-3/4"
TS-18-EZ	18"	1"	TSA-18-EZ	18"	1"	TSP-18-EZ	18"	1"	TH-18-EZ	18"	2-1/4"	THA-18-EZ	18"	2-1/4"	THP-18-EZ	18"	2-1/4"
TS-20-EZ	20"	1"	TSA-20-EZ	20"	1-1/4"	TSP-20-EZ	20"	1"	TH-20-EZ	20"	2-1/4"	THA-20-EZ	20"	2-1/2"	THP-20-EZ	20"	2-1/4"
TS-22-EZ	22"	1"	TSA-22-EZ	22"	1-1/4"	TSP-22-EZ	22"	1"	TH-22-EZ	22"	2-1/4"	THA-22-EZ	22"	2-1/2"	THP-22-EZ	22"	2-1/4"
TS-24-EZ	24"	1"	TSA-24-EZ	24"	1-1/4"	TSP-24-EZ	24"	1"	TH-24-EZ	24"	2-1/4"	THA-24-EZ	24"	2-1/2"	THP-24-EZ	24"	2-1/4"
TS-27-EZ	27"	1"	TSA-27-EZ	27"	1-1/4"	TSP-27-EZ	27"	1"	TH-27-EZ	27"	2-1/2"	THA-27-EZ	27"	2-1/2"	THP-27-EZ	27"	2-1/4"
TS-30-EZ	30"	1"	TSA-30-EZ	30"	1-1/4"	TSP-30-EZ	30"	1"	TH-30-EZ	30"	3"	THA-30-EZ	30"	2-1/2"	THP-30-EZ	30"	2-1/2"
TS-33-EZ	33"	1"	TSA-33-EZ	33"	1-1/2"	TSP-33-EZ	33"	1-1/4"	TH-33-EZ	33"	3"	THA-33-EZ	33"	3"	THP-33-EZ	33"	2-1/2"
TS-36-EZ	36"	1"	TSA-36-EZ	36"	1-1/2"	TSP-36-EZ	36"	1-1/4"	TH-36-EZ	36"	3"	THA-36-EZ	36"	3"	THP-36-EZ	36"	2-1/2"
TS-42-EZ	42"	1"	TSA-42-EZ	42"	1-1/2"	TSP-42-EZ	42"	1-1/4"	TH-42-EZ	42"	3-1/2"	THA-42-EZ	42"	3"	THP-42-EZ	42"	3"
TS-48-EZ	48"	1-1/4"	TSA-48-EZ	48"	1-3/4"	TSP-48-EZ	48"	1-1/2"	TH-48-EZ	48"	3-1/2"	THA-48-EZ	48"	3-1/2"	THP-48-EZ	48"	3"
TS-54-EZ	54"	1-1/2"	TSA-54-EZ	54"	1-3/4"	TSP-54-EZ	54"	1-1/2"	TH-54-EZ	54"	4"	THA-54-EZ	54"	3-1/2"	THP-54-EZ	54"	3"
TS-60-EZ	60"	1-3/4"	TSA-60-EZ	60"	2-1/4"	TSP-60-EZ	60"	1-1/2"	TH-60-EZ	60"	4"	THA-60-EZ	60"	4"	THP-60-EZ	60"	3-1/2"
TS-66-EZ	66"	1-3/4"	TSA-66-EZ	66"	2-1/4"	TSP-66-EZ	66"	1-1/2"	TH-66-EZ	66"	5"	THA-66-EZ	66"	4"	THP-66-EZ	66"	3-1/2"
TS-72-EZ	72"	2"	TSA-72-EZ	72"	2-1/4"	TSP-72-EZ	72"	1-3/4"	TH-72-EZ	72"	5"	THA-72-EZ	72"	4"	THP-72-EZ	72"	4"

# Inlet Grates & Frames

Complementing our trench grating systems, Grating Pacific Inlet Grates and Frames provide the specifier with flexible solutions to inlet drain requirements. Equal to our trench grating products, Standard Duty pedestrian grates and Heavy Duty vehicular grates are illustrated on page 46 of this catalog. Inlets may be specified to any clear opening by simply indicating the desired “W” (width) and “S” (span) dimensions illustrated on page 44. Similar to our trench grating systems, any of the five embed frame profiles may be specified to meet the exact needs of your application. Bolting the grates to the frames is optional and must be specified.

While all gratings are manufactured with plain walking surface, the optional serrated surface may be specified. The open ends of all inlet gratings are trench banded to enhance durability and allow for maximum drainage. Unless otherwise specified, all inlet grates and frames are hot dip galvanized in accordance with ASTM specification A-123.

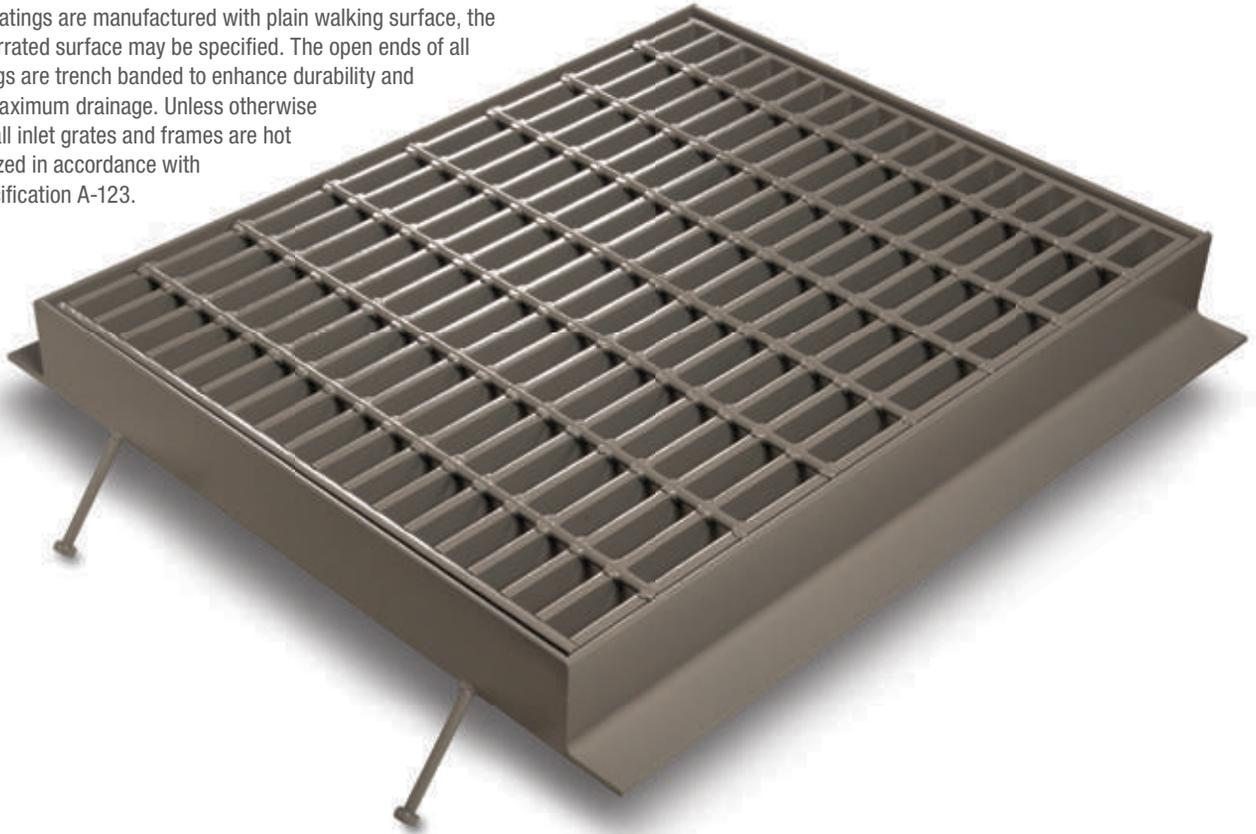

## How to Specify Inlet Grates & Frames

Inlet grates and frames are simply specified by using the following component model numbers:

**H - 3624 - EZ (B)**

Grating type from table on page 46. Specify Heavy Duty (type H, HA, or HP) or Standard Duty (type S, SA or SP)

Indicates frame “W” clear opening in inches (see page 44).

Indicates frame “S” clear opening in inches (see page 44).

Type of frame selected from sections illustrated on page 44.

Optional component to specify bolted grates. If bolted grates are not required, this suffix is omitted.

## Standard Inlet Sets

Standard Inlet Sets listed in tabular form on page 49 consist of our “E-Z Pour” frames with either of two popular series of grating. Standard Duty type “S” grates are selected for pedestrian applications and type “H” Heavy Duty grates are selected for vehicular load applications.

## Standard Duty

### Standard Duty Square Inlet Sets

Model Number	"W"	"S"	"d"	Model Number	"W"	"S"	"d"
S-0606-EZ	6"	6"	1"	S-3333-EZ	33"	33"	1"
S-0808-EZ	8"	8"	1"	S-3636-EZ	36"	36"	1"
S-1010-EZ	10"	10"	1"	S-4242-EZ	42"	42"	1"
S-1212-EZ	12"	12"	1"	S-4848-EZ	48"	48"	1-1/4"
S-1414-EZ	14"	14"	1"	S-5454-EZ	54"	54"	1-1/2"
S-1616-EZ	16"	16"	1"	S-6060-EZ	60"	60"	1-3/4"
S-1818-EZ	18"	18"	1"	S-6666-EZ	66"	66"	1-3/4"
S-2020-EZ	20"	20"	1"	S-7272-EZ	72"	72"	2"
S-2222-EZ	22"	22"	1"	S-7878-EZ	78"	78"	2-1/4"
S-2424-EZ	24"	24"	1"	S-8484-EZ	84"	84"	2-1/2"
S-2727-EZ	27"	27"	1"	S-9696-EZ	96"	96"	2-1/2"
S-3030-EZ	30"	30"	1"				

### Standard Duty Rectangular Inlet Sets

Model Number	"W"	"S"	"d"	Model Number	"W"	"S"	"d"
S-1206-EZ	12"	6"	1"	S-0612-EZ	6"	12"	1"
S-1210-EZ	12"	10"	1"	S-0618-EZ	6"	18"	1"
S-1806-EZ	18"	6"	1"	S-0624-EZ	6"	24"	1"
S-1812-EZ	18"	12"	1"	S-0630-EZ	6"	30"	1"
S-2406-EZ	24"	6"	1"	S-0636-EZ	6"	36"	1"
S-2412-EZ	24"	12"	1"	S-1218-EZ	12"	18"	1"
S-2418-EZ	24"	18"	1"	S-1224-EZ	12"	24"	1"
S-3006-EZ	30"	6"	1"	S-1230-EZ	12"	30"	1"
S-3012-EZ	30"	12"	1"	S-1236-EZ	12"	36"	1"
S-3018-EZ	30"	18"	1"	S-1248-EZ	12"	48"	1-1/4"
S-3024-EZ	30"	24"	1"	S-1824-EZ	18"	24"	1"
S-3606-EZ	36"	6"	1"	S-1830-EZ	18"	30"	1"
S-3612-EZ	36"	12"	1"	S-1836-EZ	18"	36"	1"
S-3618-EZ	36"	18"	1"	S-1842-EZ	18"	42"	1"
S-3624-EZ	36"	24"	1"	S-1848-EZ	18"	48"	1-1/4"
S-3630-EZ	36"	30"	1"	S-2430-EZ	24"	30"	1"
S-4812-EZ	48"	12"	1"	S-2436-EZ	24"	36"	1"
S-4818-EZ	48"	18"	1"	S-2442-EZ	24"	42"	1"
S-4824-EZ	48"	24"	1"	S-2448-EZ	24"	48"	1-1/4"
S-4836-EZ	48"	36"	1"	S-2454-EZ	24"	54"	1-1/2"
S-6012-EZ	60"	12"	1"	S-2460-EZ	24"	60"	1-3/4"
S-6018-EZ	60"	18"	1"	S-3036-EZ	30"	36"	1"
S-6024-EZ	60"	24"	1"	S-3042-EZ	30"	42"	1"
S-6036-EZ	60"	36"	1"	S-3048-EZ	30"	48"	1-1/4"
S-6048-EZ	60"	48"	1-1/4"	S-3054-EZ	30"	54"	1-1/2"
S-7212-EZ	72"	12"	1"	S-3060-EZ	30"	60"	1-3/4"
S-7218-EZ	72"	18"	1"	S-3072-EZ	30"	72"	2"
S-7224-EZ	72"	24"	1"	S-3642-EZ	36"	42"	1"
S-7236-EZ	72"	36"	1"	S-3648-EZ	36"	48"	1-1/4"
S-7248-EZ	72"	48"	1-1/4"	S-3654-EZ	36"	54"	1-1/2"
S-8412-EZ	84"	12"	1"	S-3660-EZ	36"	60"	1-3/4"
S-8424-EZ	84"	24"	1"	S-4248-EZ	42"	48"	1-1/4"
S-8436-EZ	84"	36"	1"	S-4254-EZ	42"	54"	1-1/2"
S-8448-EZ	84"	48"	1-1/4"	S-4260-EZ	42"	60"	1-3/4"
S-9612-EZ	96"	12"	1"	S-4854-EZ	48"	54"	1-1/2"
S-9624-EZ	96"	24"	1"	S-4860-EZ	48"	60"	1-3/4"
S-9636-EZ	96"	36"	1"	S-4872-EZ	48"	72"	2"
S-9648-EZ	96"	48"	1-1/4"	S-6072-EZ	60"	72"	2"
S-9672-EZ	96"	72"	2"				

## Heavy Duty

### Heavy Duty Square Inlet Sets

Model Number	"W"	"S"	"d"	Model Number	"W"	"S"	"d"
H-0606-EZ	6"	6"	1-1/2"	H-3333-EZ	33"	33"	3"
H-0808-EZ	8"	8"	1-1/2"	H-3636-EZ	36"	36"	3"
H-1010-EZ	10"	10"	1-1/2"	H-4242-EZ	42"	42"	3-1/2"
H-1212-EZ	12"	12"	1-1/2"	H-4848-EZ	48"	48"	3-1/2"
H-1414-EZ	14"	14"	1-3/4"	H-5454-EZ	54"	54"	4"
H-1616-EZ	16"	16"	2-1/4"	H-6060-EZ	60"	60"	4"
H-1818-EZ	18"	18"	2-1/4"	H-6666-EZ	66"	66"	5"
H-2020-EZ	20"	20"	2-1/4"	H-7272-EZ	72"	72"	5"
H-2222-EZ	22"	22"	2-1/4"	H-7878-EZ	78"	78"	5"
H-2424-EZ	24"	24"	2-1/4"	H-8484-EZ	84"	84"	6"
H-2727-EZ	27"	27"	2-1/2"	H-9696-EZ	96"	96"	6"
H-3030-EZ	30"	30"	3"				

### Heavy Duty Rectangular Inlet Sets

Model Number	"W"	"S"	"d"	Model Number	"W"	"S"	"d"
H-1206-EZ	12"	6"	1-1/2"	H-0612-EZ	6"	12"	1-1/2"
H-1210-EZ	12"	10"	1-1/2"	H-0618-EZ	6"	18"	2-1/4"
H-1806-EZ	18"	6"	1-1/2"	H-0624-EZ	6"	24"	2-1/4"
H-1812-EZ	18"	12"	1-1/2"	H-0630-EZ	6"	30"	3"
H-2406-EZ	24"	6"	1-1/2"	H-0636-EZ	6"	36"	3"
H-2412-EZ	24"	12"	1-1/2"	H-1218-EZ	12"	18"	2-1/4"
H-2418-EZ	24"	18"	2-1/4"	H-1224-EZ	12"	24"	2-1/4"
H-3006-EZ	30"	6"	1-1/2"	H-1230-EZ	12"	30"	3"
H-3012-EZ	30"	12"	1-1/2"	H-1236-EZ	12"	36"	3"
H-3018-EZ	30"	18"	2-1/4"	H-1248-EZ	12"	48"	3-1/2"
H-3024-EZ	30"	24"	2-1/4"	H-1824-EZ	18"	24"	2-1/4"
H-3606-EZ	36"	6"	1-1/2"	H-1830-EZ	18"	30"	3"
H-3612-EZ	36"	12"	1-1/2"	H-1836-EZ	18"	36"	3"
H-3618-EZ	36"	18"	2-1/4"	H-1842-EZ	18"	42"	3-1/2"
H-3624-EZ	36"	24"	2-1/4"	H-1848-EZ	18"	48"	3-1/2"
H-3630-EZ	36"	30"	3"	H-2430-EZ	24"	30"	3"
H-4812-EZ	48"	12"	1-1/2"	H-2436-EZ	24"	36"	3"
H-4818-EZ	48"	18"	2-1/4"	H-2442-EZ	24"	42"	3-1/2"
H-4824-EZ	48"	24"	2-1/4"	H-2448-EZ	24"	48"	3-1/2"
H-4836-EZ	48"	36"	3"	H-2454-EZ	24"	54"	4"
H-6012-EZ	60"	12"	1-1/2"	H-2460-EZ	24"	60"	4"
H-6018-EZ	60"	18"	2-1/4"	H-3036-EZ	30"	36"	3"
H-6024-EZ	60"	24"	2-1/4"	H-3042-EZ	30"	42"	3-1/2"
H-6036-EZ	60"	36"	3"	H-3048-EZ	30"	48"	3-1/2"
H-6048-EZ	60"	48"	3-1/2"	H-3054-EZ	30"	54"	4"
H-7212-EZ	72"	12"	1-1/2"	H-3060-EZ	30"	60"	4"
H-7218-EZ	72"	18"	2-1/4"	H-3072-EZ	30"	72"	5"
H-7224-EZ	72"	24"	2-1/4"	H-3642-EZ	36"	42"	3-1/2"
H-7236-EZ	72"	36"	3"	H-3648-EZ	36"	48"	3-1/2"
H-7248-EZ	72"	48"	3-1/2"	H-3654-EZ	36"	54"	4"
H-8412-EZ	84"	12"	1-1/2"	H-3660-EZ	36"	60"	4"
H-8424-EZ	84"	24"	2-1/4"	H-4248-EZ	42"	48"	3-1/2"
H-8436-EZ	84"	36"	3"	H-4254-EZ	42"	54"	4"
H-8448-EZ	84"	48"	3-1/2"	H-4260-EZ	42"	60"	4"
H-9612-EZ	96"	12"	1-1/2"	H-4854-EZ	48"	54"	4"
H-9624-EZ	96"	24"	2-1/4"	H-4860-EZ	48"	60"	4"
H-9636-EZ	96"	36"	3"	H-4872-EZ	48"	72"	5"
H-9648-EZ	96"	48"	3-1/2"	H-6072-EZ	60"	72"	5"
H-9672-EZ	96"	72"	5"				

Any of the above Inlet Sets can be customized to meet the specific needs of your construction project. To select Standard Duty ADA conforming or close mesh gratings, simply substitute "SA" or "SP" in lieu of the "S" component in the model number. Heavy Duty models can be similarly modified by inserting "HA" or "HP." To select alternative frame construction, select the frame type from page 44 and replace component "EZ" in the model number. Bolted grates must be specified by adding the "(B)" suffix to the model number.

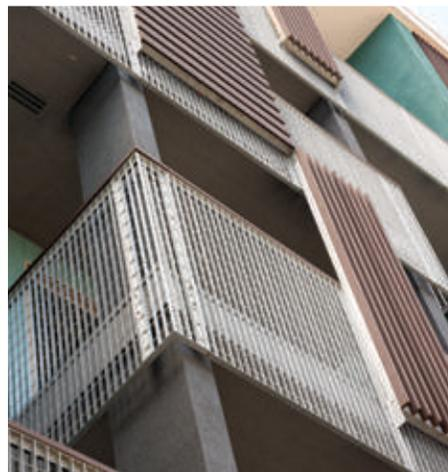
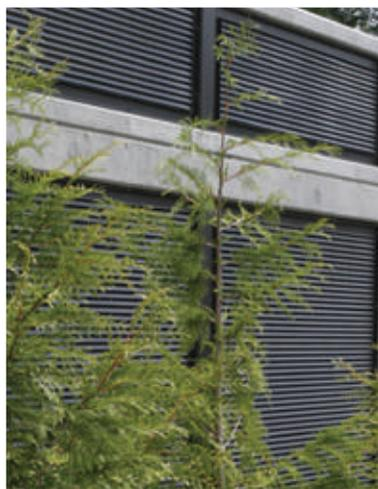

Grating Pacific is proud to present Coda Architectural, a new and exciting collection of architectural products. Designed as a solution for infill panels, fences, trellises, sunscreens, and louvers, these products combine aesthetics with security and code compliance.

The Opus line represents the marquee offering from Coda Architectural. Infused with European design, these products provide a distinct yet complementary accent. Opus products are available in a series of square and rectangular patterns that serve as the foundation for any design. Panels are easily fabricated with contours, diagonals, and finish trim to build creative solutions that seamlessly blend with adjacent architecture. Finished in a variety of metallic and organic coatings, the panels provide an aesthetic solution to screening and fencing applications of all types.

***Visual elegance, distinct flexibility, expressive aspects . . . Coda Architectural®.***

- Architectural, industrial and residential applications
- Timeless square and rectangular patterns
- Maximum design flexibility
- Discreet to prominent security
- Wide variety of finishes and colors

## OPUS10

The most widely used rectangular design, Opus10 features timeless lines combined with unmatched versatility. Opus10 is a cost-effective solution to fencing requirements providing a unique blend of security and aesthetics.

Weight Per Square Foot	
3mm Main Bar	2.2#/sq. ft.
2mm Main Bar	1.6#/sq. ft.

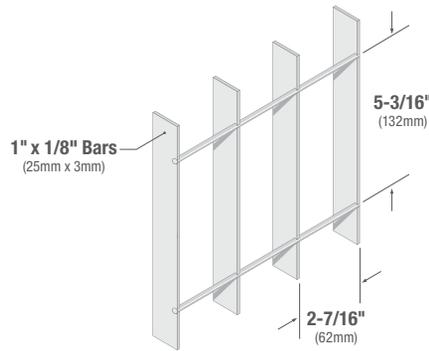

## OPUS20

The most popular square mesh pattern, Opus20 subtly suggests strength, rigidity, and security. This ideal solution for industrial and commercial applications provides a superior strength-to-weight ratio over other economical fencing products.

Weight Per Square Foot	
3mm Main Bar	2.5#/sq. ft.
2mm Main Bar	1.8#/sq. ft.

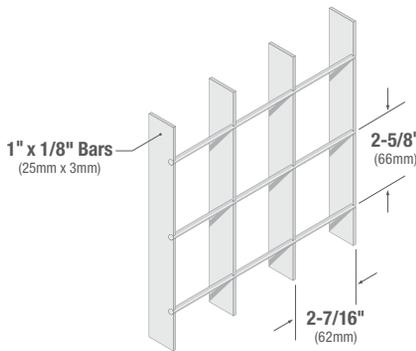

## OPUS30

The more closely spaced main elements of this classic design make Opus30 the perfect choice where increased visual blocking is preferred. The added strength and rigidity of the panel allows for more sturdy fences and enclosures.

Weight Per Square Foot	
3mm Main Bar	3.1#/sq. ft.
2mm Main Bar	2.2#/sq. ft.

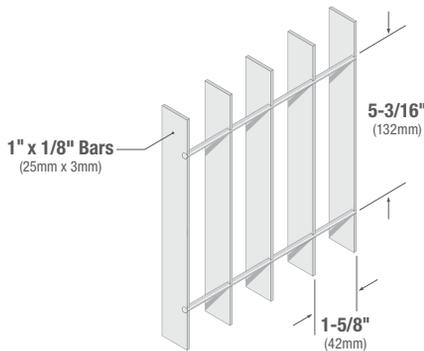

## OPUS40

The extremely rigid characteristics of the popular Opus40 design provide a closely spaced nominal square pattern with increased strength and security. Opus40 is ideally suited for shorter fences and infill panel requirements.

Weight Per Square Foot	
3mm Main Bar	3.3#/sq. ft.
2mm Main Bar	2.4#/sq. ft.

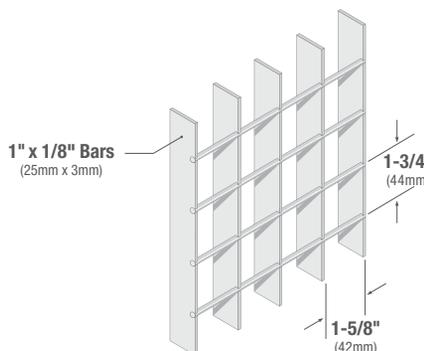

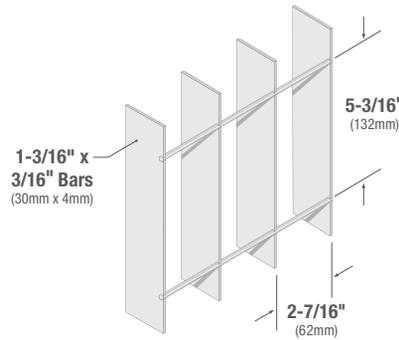

## OPUS50

Designed to provide increased depth and strength of the main elements, Opus50 incorporates a deeper bar section while maintaining the same timeless spacing pattern of the most popular Opus10 design.

Weight Per Square Foot	
4mm Main Bar	3.6#/sq. ft.

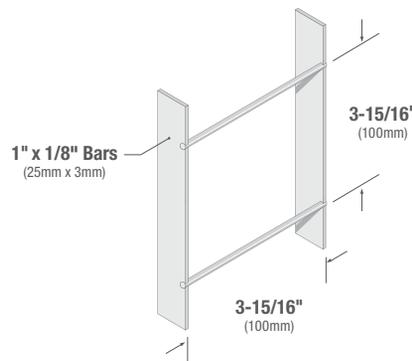

## OPUS60

The enduring square pattern of Opus60 complies with IBC spacing requirements for infill panels of all types. The open matrix minimizes visual obstruction while attractively maintaining security and code compliance.

Weight Per Square Foot	
3mm Main Bar	1.2#/sq. ft.
2mm Main Bar	1.0#/sq. ft.

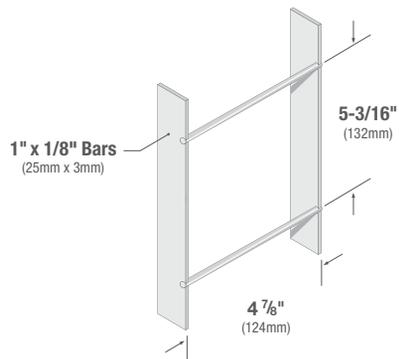

## OPUS70

Light and airy, the Opus70 design provides for a modular perimeter fence that blends into the background while providing a permanent physical barrier.

Weight Per Square Foot	
3mm Main Bar	1.3#/sq. ft.
2mm Main Bar	1.0#/sq. ft.

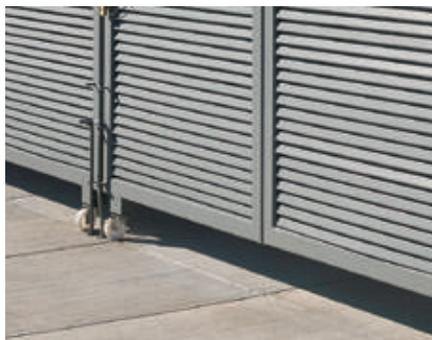

## OPUSGATES

Coda Architectural is pleased to offer a complete array of fabricated OpusGates. Using any Opus grid or louvered pattern as the main visual element, gates are available in both standard and custom designs to complement adjacent fencing and architecture.

## CODA ARCHITECTURAL LOUVERED PANELS

### OPUS80

Louvered main elements make Opus80 the ideal panel for applications that require ventilation and minimal visual access. Opus80 provides a distinct look, with 80% visual concealment and 45% free air flow.

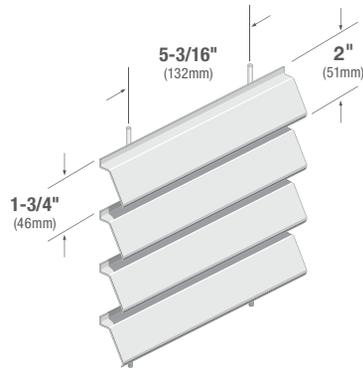

**Weight Per Square Foot**

1/16" Louver | 3.0#/sq. ft.

### OPUS100

Concealment and ventilation are merged with the Opus100 design. This stylish panel provides 100% concealment by combining louvered bars and permanently welded cross bars behind the panel.

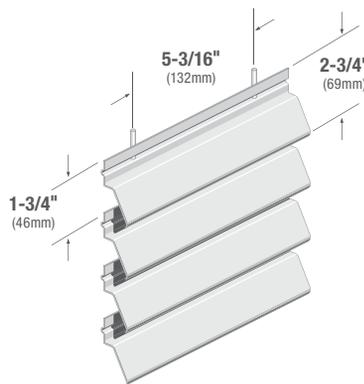

**Weight Per Square Foot**

1/16" Louver | 4.3#/sq. ft.

## RAIL OPTIONS

Various cap rails are available for welding to the edge of the finished panel. Rails may be bolted or welded to supporting structures to facilitate efficient field assembly.



**Trim Band**  
Flat bar welded to end of panel. Often formed and punched for attachment.



**Plate Band**  
Various widths of oversized flat bar may be welded to end of panel.



**U-Edge**  
Steel plate formed and welded to the edge of the panel.



**Mold Cap**  
Ornamental, mill rolled steel bar with a distinctive design welded to panel edge.



**Tube Frame**  
Tubes of various sizes may be used to complement adjacent architecture.

Additional product information, application, accents, colors, finishes, and downloadable specifications for Coda Architectural Products can be found on our website: [www.gratingpacific.com](http://www.gratingpacific.com)

## Aluminum Louver Grate

### LG-Louver Series

Manufactured from aluminum extrusions, LG series Louver Grate is designed to offer an economical solution for architectural applications. Available in four popular patterns with total or partial visual concealment, all LG series products offer a minimum 63% open air flow. Popular applications include sunscreens, visual barriers, security systems, and fencing.

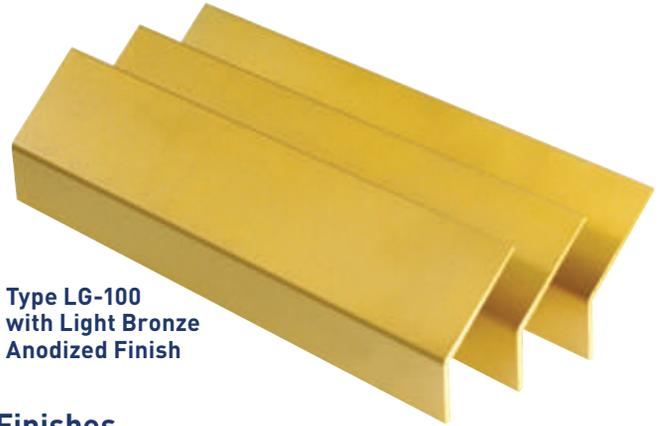

**Type LG-100  
with Light Bronze  
Anodized Finish**

### Finishes

The natural corrosion resistance and beauty of mill finish aluminum can be enhanced with clear anodizing. Other popular anodizing options include light and dark bronze shades.

For an alternative appearance, powder coating, epoxy, and Kynar finishes are available in the complete RAL color palette. Properly applied, these finishes offer years of continuing service in colors designed to complement the look and feel of adjacent architecture.

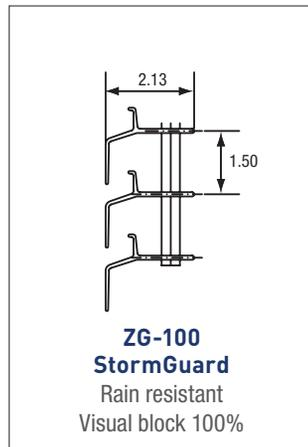
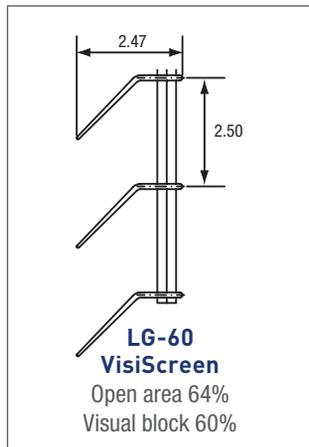
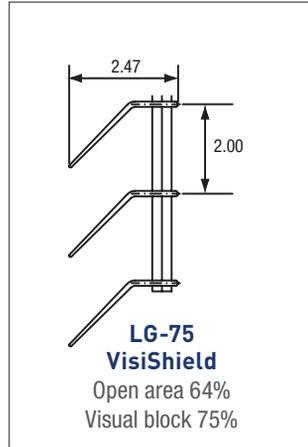
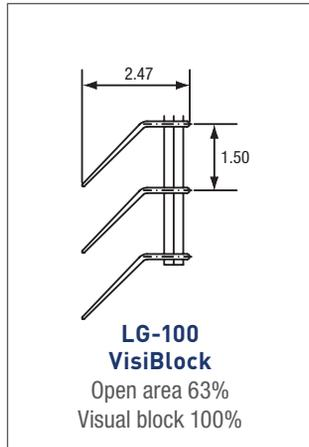

### Louver Grate Load Table

Part No.	Product	Weight (lbs. psf)	Sec. Prop. per ft. width S <sub>x</sub> , in <sup>3</sup> I <sub>x</sub> , in <sup>4</sup>		Clear Span								
					5'-0"	6'-0"	7'-0"	8'-0"	9'-0"	10'-0"	11'-0"	12'-0"	
LG-100	VisiBlock	3.6	1.017	U	325	226	166	127	100	81	67	57	
				D	0.365	0.526	0.715	0.934	1.182	1.460	1.766	2.102	
LG-75	VisiShield	2.8	0.773	U	247	172	180	97	76	62	51	43	
				D	0.365	0.526	1.020	0.934	1.183	1.460	1.767	2.102	
LG-60	VisiScreen	2.4	0.626	U	200	139	102	78	62	50	41	35	
				D	0.364	0.525	0.714	0.933	1.181	1.458	1.764	2.099	

U = uniform load in lbs./sq. ft.  
D = deflection in inches

**Note:** Loads and deflections provided in this table are theoretical and are based on a unit stress of 12,000 psi.



VisiScreen panels placed vertically conceal rooftop mechanical systems.

## Vertical & Horizontal Installation

The unique flexibility of the LG series allows architectural freedom for both vertical and horizontal applications. Vertical applications allow for maximum air flow and resist the accumulation of snow, rain, dirt, and debris. Screening of parking structures and visual concealment of unsightly ventilation or mechanical equipment is easily accomplished.

Installed horizontally, the multiple tilt patterns provide options for sunscreens and building facades. Once again the high percentage of open area allows for important air circulation and the free passage of moisture.

## Fabrication

LG series products are easily fabricated to any size and configuration. Radial or diagonal cuts accommodate “free-form” design beyond simple squares and rectangles. Louvers can be welded into component framework and quickly bolted to the supporting structure with limited field labor. All fabrication can be completed prior to finishing thereby maximizing the integrity of the coating.



VisiShield panels placed horizontally provide solar protection at building entrance.



Louver Grate panels are a distinct and practical accent for building facades.

# Architectural Products

## Architectural Applications

Grating Pacific's complete line of bar gratings and architectural products offer a distinct, contemporary design that is easily incorporated as an architectural accent. Increased spacing between the bearing bars provides security and structural integrity without restricting sight lines and ventilation. The perfect merger of form and function, these products can be fully fabricated to complement design creativity.

- Security
- Ventilation
- Fencing
- Handrail infill
- Sunscreens
- Architectural accents



Type "W" welded steel grating fence panels



Type "SG" aluminum panels installed as radial accent



Type "SL" ground floor security/ventilation screen



Type "SGF" accent screen



Type "DT" handrail infill panels

## Architectural Patterns

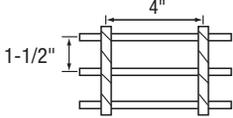
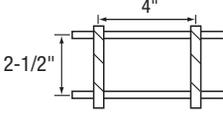
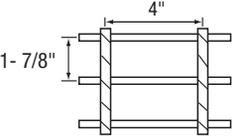
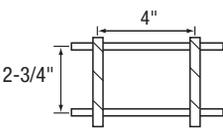
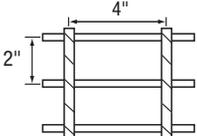
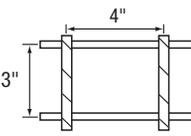
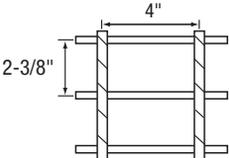
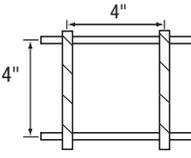
<b>24-x-4</b>  Bearing Bars @ 1-1/2" O.C. Cross Bars @ 4" O.C.	<b>40-x-4</b>  Bearing Bars @ 2-1/2" O.C. Cross Bars @ 4" O.C.
<b>30-x-4</b>  Bearing Bars @ 1-7/8" O.C. Cross Bars @ 4" O.C.	<b>44-x-4</b>  Bearing Bars @ 2-3/4" O.C. Cross Bars @ 4" O.C.
<b>32-x-4</b>  Bearing Bars @ 2" O.C. Cross Bars @ 4" O.C.	<b>48-x-4</b>  Bearing Bars @ 3" O.C. Cross Bars @ 4" O.C.
<b>38-x-4</b>  Bearing Bars @ 2-3/8" O.C. Cross Bars @ 4" O.C.	<b>64-x-4</b>  Bearing Bars @ 4" O.C. Cross Bars @ 4" O.C.

Each product is available in steel, aluminum, or stainless steel, assembled by any of the manufacturing methods presented on page 2 of this catalog. To specify the appropriate material and manufacturing method, replace the "x" in the above part number with any of the following designations:

### For Steel Products

"W" for Welded Grating  
 "DT" for Dovetail Pressure Locked  
 "SL" for Swage Locked

### For Aluminum Products

"SG" for Swage Locked  
 "ADT" for Dovetail Pressure Locked  
 "SGI" for Swaged I-Bar  
 "SGF" for Swaged Flush Top

### For Stainless Steel Products

"WS" for Welded Grating  
 "DTS" for Dovetail Pressure Locked  
 "SLS" for Swage Locked

## Bearing Bar Sizes

Select from the following range of bearing bars:

1" x 1/8"	1" x 3/16"
1-1/4" x 1/8"	1-1/4" x 3/16"
1-1/2" x 1/8"	1-1/2" x 3/16"
1-3/4" x 1/8"	1-3/4" x 3/16"
2" x 1/8"	2" x 3/16"
	2-1/4" x 3/16"
	2-1/2" x 3/16"
	3" x 3/16"

### Contact Grating Pacific for additional custom products including:

- Additional bearing bar sizes and spacings
- Additional cross bar spacings
- Full-depth rectangular cross bars
- Special fabrication and finishing

## Sample specifications:

**32-W-4 1 x 1/8** for welded steel with 1" x 1/8" bearing bars at 2" on center and welded cross bars at 4" on center.

**40-ADT-4 1-1/2 x 3/16** for dovetail aluminum with 1-1/2" x 3/16" bearing bars at 2-1/2" on center and cross bars at 4" on center.

**38-SLS-4 2 x 3/16** for swage locked stainless steel with 2" x 3/16" bearing bars at 2-3/8" on center and cross bars at 4" on center.



# Banding & Panel Layout

## Banding

As manufactured, grating panels are provided with open ends. Optional trim banding, a metal flat bar welded to the open ends of the panel, provides additional transverse stiffness and a finished architectural appearance. Banding should be specified for all removable grating panels as the closed ends provide additional worker safety during handling.

Gratings subject to vehicular loads should always be specified as banded. In these applications, the band bar helps reduce impact stresses by transferring loads to adjacent bearing bars and resists deformation caused by repetitive traffic patterns on open end gratings.

Load banding, where each bearing bar is welded to the band bar, helps distribute load throughout the grating panel.

Trench banding, where the band bar is elevated above the bottom of the bearing bars, is appropriate for drainage applications. The elevated band bar allows for efficient drainage and will not trap liquids between the band bar and the grating support.

See Banding Weld Standards for specific welding practices.

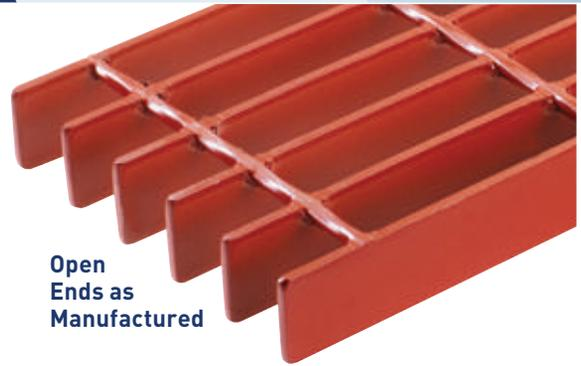

Open Ends as Manufactured



Standard Trim Banding



Trench Banding

## Banding Weld Standards

### For grating with bearing bars less than 2-1/2" deep: Standard Trim Banding

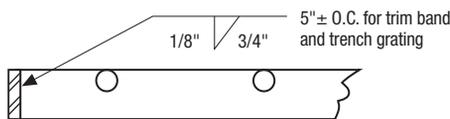

### For grating with bearing bars 2-1/2" and deeper:

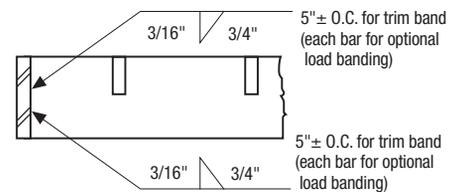

NOTE: Weld one side at top of bearing bar – opposite side at bottom, or weld one side only and exceed one-half the overall depth.

### Load Banding (Optional)

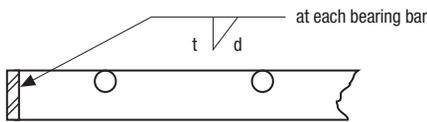

### Trench Banding

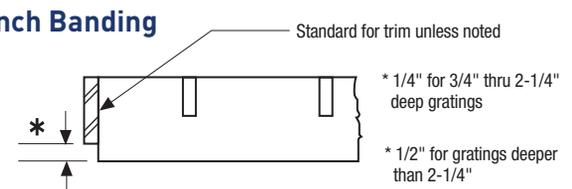

## Panel Layout

Stock grating panels are manufactured in nominal 24", 36", and 48" widths. These sizes allow for efficient layout and waste minimization when fabricated to your exact specification. Unlike competing grating products, individual grating panels do not require supports on all four sides of each cut piece. Bar grating panels only require support perpendicular to the bearing bar span. There is no need to place supports parallel to the bearing bars where adjacent panels are installed in succession. The following diagrams illustrate proper layout and support of a simple bar grating platform.

### Typical Panel Layouts

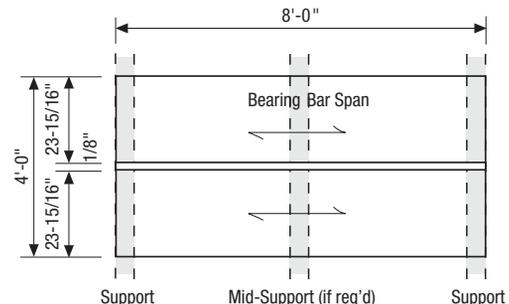
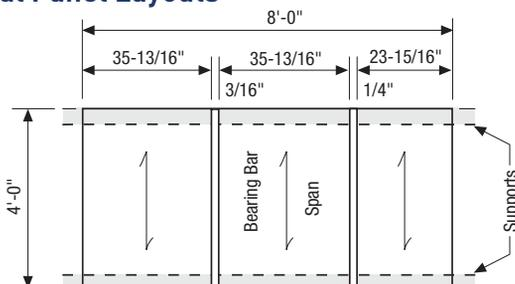

## Welded Installation

All grating must be firmly fastened in place and welding panels to the supporting structure provides a superior, permanent installation. The diagram to the right indicates the recommended minimum weld size and spacing for pedestrian applications.

Vehicular applications typically require additional welding, size and spacing as determined by the specifying authority.

## Minimum Weld Pattern

One weld in middle of panel at each intermediate support

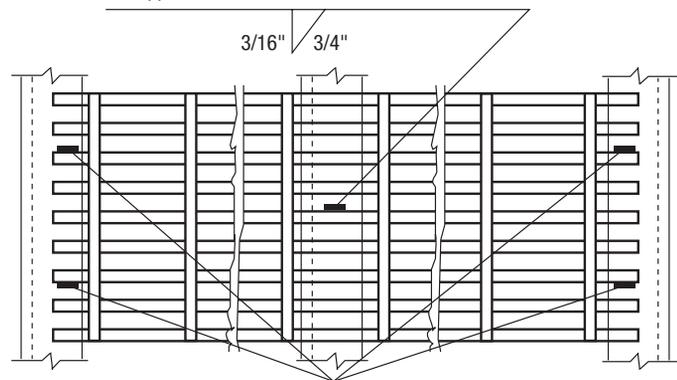

Welds at ends of bearing bar approximately 6 inches from each side of panel



## Fasteners

When the grating is designed to be removable or when welding is not practical, consider the mechanical fasteners below. The minimum fastener spacing for pedestrian applications is equal to the minimum weld pattern illustrated above.



### Saddle Clips

Bent clips bridging two bearing bars, available in galvanized steel, stainless steel, or aluminum. Standard bolt holes are 5/16" and bolts, screws, or other connecting hardware shall be supplied by others.



### Countersunk Lands

The narrow spacing of close mesh gratings allows for countersinking or milling of the bearing bars to support bolt shoulders. Flat head screws or self-drilling fasteners shall be supplied by others.



### Weld Lugs

Plates punched with holes and shop welded between the bearing bars facilitate bolting to the supporting structure. Bolts, screws, or other connecting hardware shall be supplied by others.



### "G" Clips

Mechanical fasteners that are installed on the top surface of the grating and create a friction connection with the flange supporting the panel. "G" Clips are easily installed without drilling or welding.



### "J" Clips

Bent clip capturing one bearing bar, frequently used with 11/16" on center bearing bars. Cap screws or other fastening hardware shall be supplied by others.

## Manufacturing Tolerances

### Squareness & Overall Dimensions

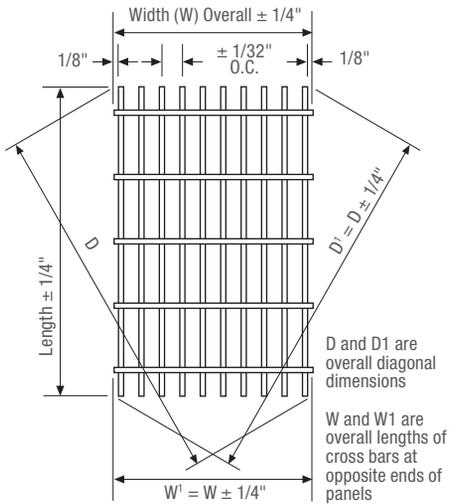

### Cross Bar Alignment & Spacing

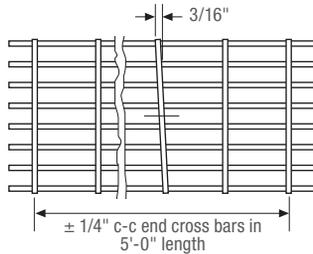

### Cross Bar Location

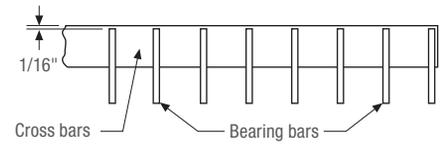

**All Dimensions are Maximum Permissible**

### Longitudinal Bow

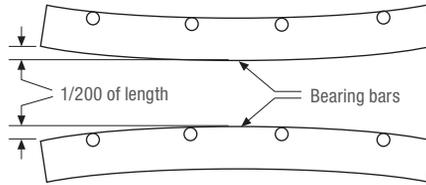

### Transverse Bow

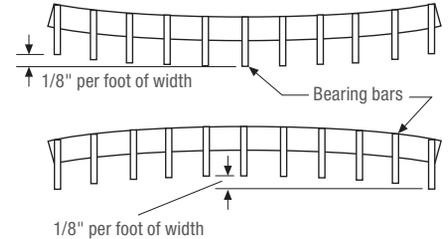

### Bearing Bar Lean

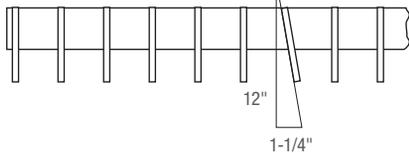

### Stair Tread Carrier Plate Lean

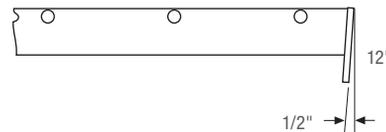

### Stair Tread Tolerance

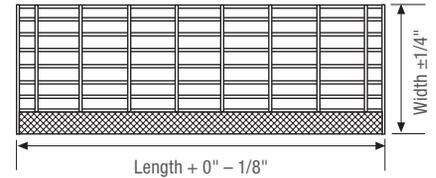

## Installation Clearances

### Handrail Posts & Toe Plate

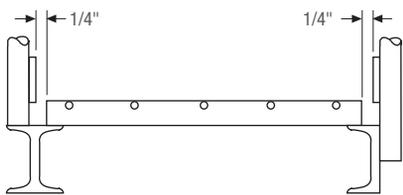

### Beam & Channel

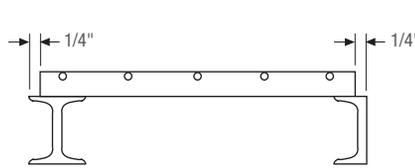

### Panel Clearances

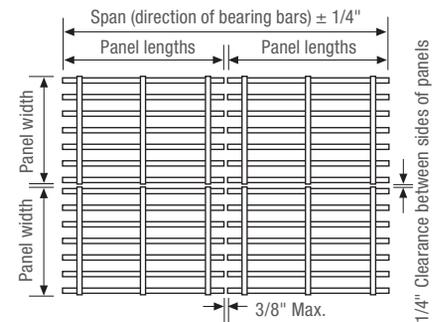

### Angle Support in Concrete

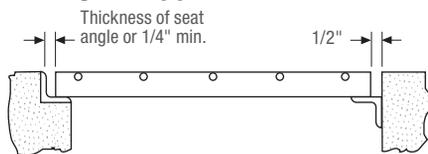

### Circular Cuts

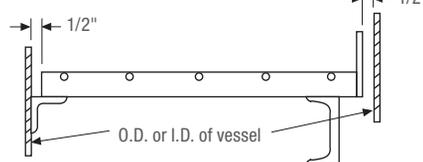

### Toe Plate Weld Standards

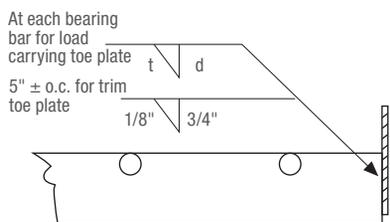

### Cut-Outs Made to Closest Adjacent Bearing Bars

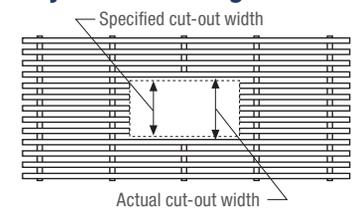

**Anchor** – A device by which grating is attached to its supports.

**Band** – A flat bar welded to the end of a grating panel, or along the side of a cutout, and extending neither above nor below the bearing bars.



**Load Carrying Band:** A band used to transfer load between bearing bars.

**Trim Band:** A band which carries no load, used primarily for appearance and closing open ends.

**Bearing Bars** – Load carrying main elements made from steel, aluminum, or stainless steel, extending in the direction of the grating span.

**Bearing Bar Centers** – The distance center-to-center of the bearing bars.

**Carriers** – Flats or angles which are welded to the grating panel and nosing of a stair tread and are bolted to a stair stringer to support the tread.

**Clear Opening** – The distance between faces of bearing bars in rectangular gratings, or between a bent connecting bar and a bearing bar in a riveted grating.

**Cross Bars** – The connecting bars which extend across the bearing bars, usually perpendicular to them. They may be bent into a corrugated or sinuous pattern and, where they intersect the bearing bars, are welded, forged or mechanically locked to them.

**Cross Bar Centers** – The distance center-to-center of the cross bars.

**Curved Cut** – A cutout following a curved pattern.

**Cutout** – An area of grating removed to clear an obstruction or to permit pipes, ducts, columns, etc. to pass through the grating.

**Electro-Forged** – A process of combining hydraulic pressure and heat fusion to forge bearing bars and cross bars into a panel grid.

**Finish** – The coating, commonly paint or galvanizing, which is applied to the grating.

**Flush-Top Grating** – A type of pressure-locked grating in which the cross bars and bearing bars are in the same plane relative to the top surface of the grating.



**Grating** – An open grid assembly of metal bars, in which the bearing bars, running in one direction, are spaced by rigid attachment to cross bars running perpendicular to them or by bent connecting bars extending between them.

**Hinged Panel** – Grating panels which are hinged to their supports or to other grating parts.



**I-Bar** – An extruded aluminum bearing bar having a cross sectional shape of the letter “I”. (Commonly with a striated walking surface)

**Length** – Refer to Span of Grating

**Load Carrying Band** – see Band

**Nosing** – A special “L” section member serving as the front or leading edge of a stair tread, or of grating at the head of a stair.

**Pressure Locked Grating** –

Bearing bars are locked in position by cross bar deformation instead of riveting or welding. Several proven methods include:

- Expansion of an extruded or drawn tubular cross bar
- Extruded cross bar deformed or swaged between bearing bars
- Press assembly of rectangular cross bars into slotted bearing bars



**Radially Cut Grating** – Rectangular grating which is cut into panels shaped as annular segments, for use in circular or annular areas.

**Reticuline Bar** – A sinuously bent connecting bar extending between two adjacent bearing bars, alternately contacting and being riveted to each.

**Rivet Centers** – The distance center-to-center of rivets along one bearing bar.

**Riveted Grating** – Grating composed of straight bearing bars and bent connecting bars, which are joined at their contact points, by riveting.

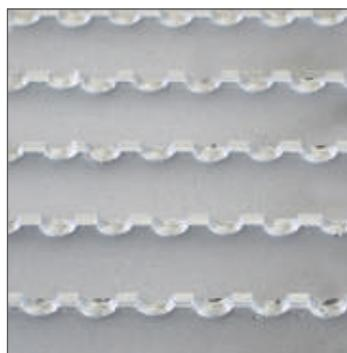

**Serrated Grating** – Grating which has the top surfaces of the bearing bars or cross bars, or both, notched.

**Span of Grating** – The distance between points of grating support, or the dimension of the bearing bars in this direction.

**Straight Cut** – Portion of the cut edge or cutout of a grating which follows a straight line.

**Swaging** – A method of altering the cross-section shape of a metal bar by pressure applied through dies.

**Toe Plate** – A flat bar attached against the outer edge of a grating or rear edge of a tread, and projecting above the top surface of the grating or tread to form a lip or curb.

**Tread** – A panel of grating having carriers and a nosing attached by welding, and designed specifically to serve as a stair tread.

**Trim Band** – see Band

**Welded Grating** – Grating in which the bearing bars and cross bars are joined at their intersections by either electro-forging or conventional hand welding.

**Width** – The overall dimension of a grating panel, measured perpendicular to the bearing bars, and in the same direction as the cross bars.

Service. Quality. Reliability.

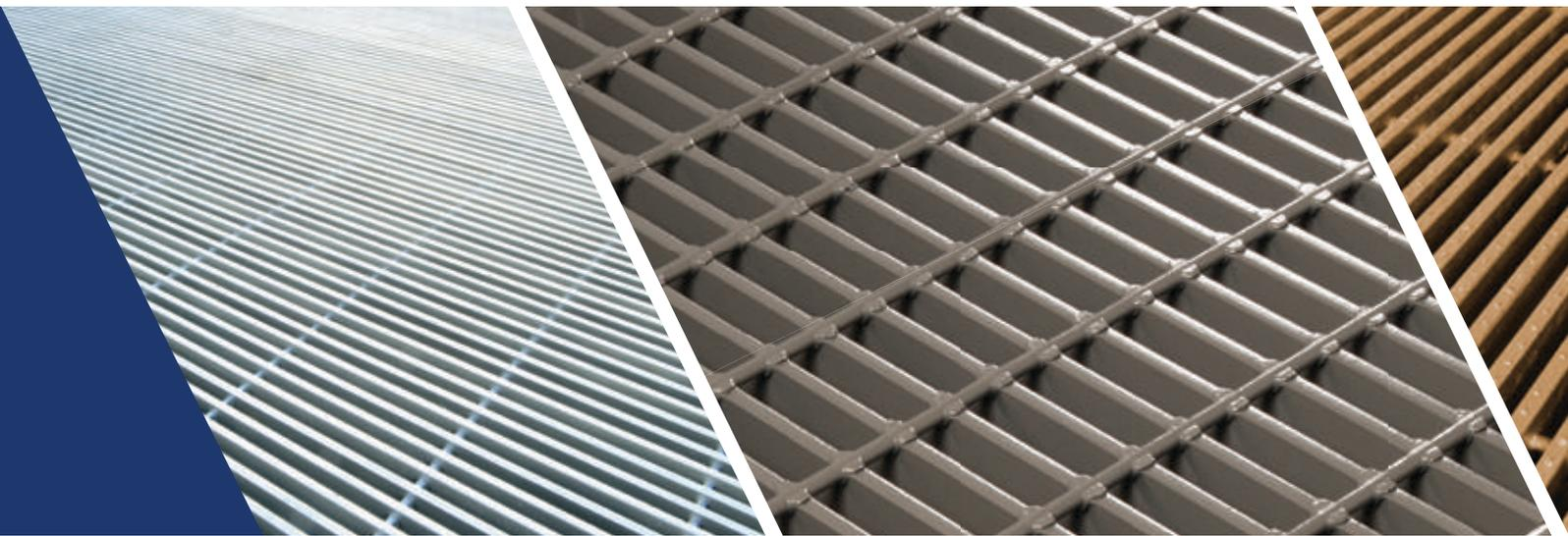

# GRATING PACIFIC

## **Southern California**

Grating Pacific, Inc.  
3651 Sausalito Street  
Los Alamitos, CA 90720  
Phone (800) 321-4314  
Fax (562) 598-2740

## **Central/Northern California**

Grating Pacific, Inc.  
1398 Mariani Court, Unit 120  
Tracy, CA 95376  
Phone (800) 491-7999  
Fax (209) 832-6311

## **Oregon**

Grating Pacific, LLC  
2775 N. Front Street  
Woodburn, OR 97071  
Phone (800) 942-4041  
Fax (503) 980-2068

## **Washington**

Grating Pacific, LLC  
19411 66th Avenue South  
Kent, WA 98032  
Phone (800) 243-3939  
Fax (253) 872-8833

## **Arizona**

Grating Pacific Southwest, LLC  
7310 W. Roosevelt, Ste. 34  
Phoenix, AZ 85043  
Phone (888) 936-9201  
Fax (623) 936-9550

For more information, visit our website [www.gratingpacific.com](http://www.gratingpacific.com)

Email: [sales@gratingpacific.com](mailto:sales@gratingpacific.com)